



➤ **POLYETHYLENE  
WASTEWATER DRAINAGE  
PIPES & FITTINGS**

[millpro.com.hk](http://millpro.com.hk)







# Contents

<b><u>Conversion Tables</u></b> .....	3
<b><u>Drainage Pipes</u></b> .....	4
<b><u>Couplers</u></b> .....	9
<b><u>Manhole Connectors</u></b> .....	12
<b><u>Transitions / Adaptors</u></b> .....	19
<b><u>P-Traps</u></b> .....	21
<b><u>Drops &amp; Elbows</u></b> .....	23
<b><u>Bends</u></b> .....	32
<b><u>Intakes</u></b> .....	41
<b><u>Reducers</u></b> .....	52
<b><u>Odour Abatement Device</u></b> .....	54
<b><u>Rehabilitation</u></b> .....	57

---

# OD-DN Conversion Tables

## *DSD polyethylene Outside Diameter (OD) conversion to Nominal Diameter (DN)*

The Hong Kong Drainage Services Department (DSD) publishes a conversion table in Appendix 5A, to ensure proper ID alignment when connecting Polyethylene pipes with other pipe materials used in its pressure and drainage network.

PE pipe size is defined by its outside diameter (DN/OD for pipes and dn for fittings), whereas Ductile Iron, Reinforced Concrete, Earthenware and other wastewater pipe materials are defined by their nominal Bore (DN).

It should be noted that PE pipes internal dimension varies depending on the pipes wall thickness (SN / SDR Rating). The table below provides the official DSD PE OD to DN conversions, as given in DSD PS Appendix 5A, for both pressure and gravity drainage.

PE Nominal Size (DN/OD)/Nominal Outside Diameter (d <sub>n</sub> ) <i>(Outside diameter of PE Pipes/Fittings)</i>	Equivalent Size in DN / ID <i>(DSD nominated matching size DN)</i>
110	100
160	150
225	200
250	225
280	250
355	300
400	375
450	400
500	450
560	500
630	525
710	600
800	675
900	825
1000	900
1200	1050
1400	1200
1600	1350
1800	1650
2000	1800

**Note:** Larger sizes are not stipulated in Appendix 5A, but are available up to DN/OD 2800 in PN8 SDR21.

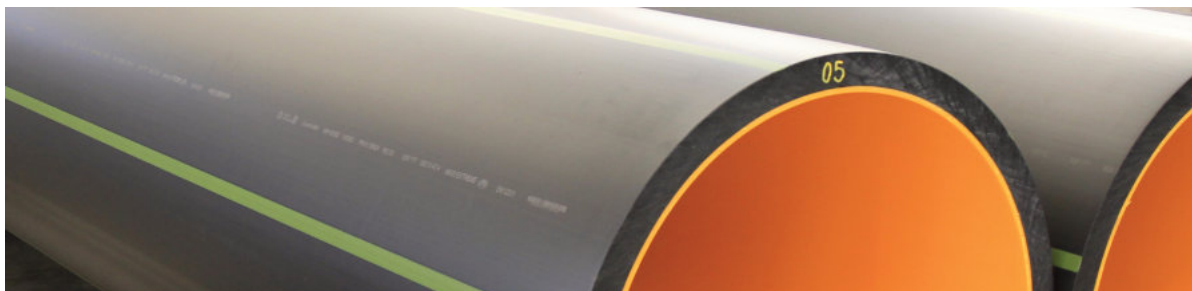

## Drainage Pipes

**M90SE** is a black PE100 RC pipe with single external stripes to identify the pipes application (Drainage, Sewer or Stormwater) and light coloured internal layer to assist with CCTV inspection. The three elements of the pipe CCTV pipe are co-extruded to BS EN 12210-2, using PE100 RC compounds complying to BS EN 12201-1. The three elements of a CCTV pipe are the inner orange layer, identification stripes and the black pipe body. These produce a single homogeneous pipe, meaning the colour layer and stripes cannot be separated in any way once the pipe is extruded. M90SE pipe is supplied in sizes from DN100 (110mm OD) to DN 1350 (1600mm OD) using PE100 RC compounds as standard. PE100+ compounds (Non RC pipe) is only supplied if specially ordered as M90S pipe.

**CCTV PIPE** has an inner light orange colour layer (See Fig. 2 - RAL 2003 in granule form) which is 15% of the pipes wall thickness. Orange PE100 RC pipe grade material is typically used for the manufacturer of Gas pipes and it is supplied pre-coloured, ready to extrude by the compound manufacturer. DSD Appendix 5A Clause 3.1 states compounds may not be pigmented or coloured by the pipe manufacturer. Factory pigmented compounds or using different grades or brands of PE presents a risk of incompatibility during extrusion, typically delamination of the layers, leading to structural wall failure in the pipe and ultimately premature pipe failure.

**CCTV Colour layer** – *Because the Orange thickness is specified at 15% of the pipes wall thickness, the colour of the inner CCTV lining varies according to the diameter of the pipe. In small pipes DN100 (110 OD), the Orange colour is approx 1.0mm thick, it is more translucent against the black compound and appears lighter (more yellow) in colour. As the pipe size increases, the orange layer becomes thicker, translucency reduces, until it is bright orange. Full orange colour occurs in sizes of approximately DN300.*

**STRIPES** are used to identify the pipes application (Pressure or Drainage, Sewer or Stormwater). The Hong Kong Drainage Services Department (DSD) uses the European colour coding system:

- Red Brown (RAL 8012) - indicates Sewerage use (See Fig.4 below)
- Fern Green (RAL 6025)- indicates Stormwater use (See Fig.5 below)
- Single stripes around the circumference of the pipe - indicate gravity drainage (non-pressure)
- Pairs of stripes around the circumference of the pipe - indicate rising main (pressure).

*Product specifications and dimensions are subject to change without notice.*

*For the latest information refer to our website: [www.millpro.com.hk](http://www.millpro.com.hk) or contact our [sales team](#).*



*This mark is used to identify Mill-Pro products that meet the requirements of the Drainage Supplies Department PS Appendix 22.09. The use of this mark is not endorsed by the DSD and is not intended to infer approval by the DSD.*



## PIPE MANUFACTURING STANDARDS

All Mill-Pro pipes and fittings are manufactured in accordance with:

BS EN 12201-1 for Compounds,

BS EN 12201-2 for Pressure pipes

BS EN 12201-3 for Pressure fittings

Drainage Services Department Particular Specification Appendix 5A

Mill-Pro Pipes and fittings also comply with ISO 4427-1/2 and AS/NZS 4130 for pipe, AS/NZS 4131 for PE Compounds and AS/NZS 4129 for fittings, although not marked as such.

## PIPE COMPOUNDS

**M90S / M100S pipes** are manufactured from a PE100+ association approved compound providing 1000 hrs slow crack growth performance. Since 2007 PE100+ compounds have been progressively superseded by PE100 RC (Resistant to Crack) compounds, which provide far superior performance and life. Mill-Pro only supplies M90S / M100S pipes by special order.

**M90SE / M100SE Extreme pipes** are manufactured ONLY using PE100 RC compounds for the pipe body, the CCTV layer and the stripes. PE100 RC compounds provide approximately 8 x greater slow crack growth resistance when compared to traditional PE100+ Compounds, for a negligible extra cost. All pipes supplied by Mill-Pro in Hong Kong are PE100 RC (M90SE / M100SE).

**PE100 RC** (Resistant to Crack) sometimes known as Extreme Stress Crack Resistant (ESCR) or High-Stress Crack Resistant (HSCR) compounds, are defined in the German publicly available standard: PAS 1075:2009-04. PE100 RC compounds are designed to provide lifelong resistance (>100 years) to traditional Slow Crack Growth (SCG) failures caused by rock impingement and point loading stress.

Designed for applications all commonly found in Hong Kong: Where sand bedding around the pipe is not used, where backfill material is ungraded and typically contains broken concrete or where secondary excavation (repeated excavation alongside the PE pipe, to access other services in close proximity) leaves the PE pipes without the required bedding around the pipe to prevent rocks or concrete point loading on the pipe surface.

### List of manufacturers of PE100 RC compounds – updated Q2 2021

Below is the list of approved PE100 RC compounds produced by PE100 Plus manufacturers worldwide. If the proposed compound supplier is not on this list, the compound is NOT an approved PE100 RC compound. To comply with the DSD PS Appendix the compound supplier must be on this list.

Manufacturer	Compound Model / Datasheet	Colour	RAL Certification	Density (Compound)	MFI (190°/5.0kg)	OIT
Borealis	Boresafe HE3490LS-H	Black	RAL 9011	959 kg/m <sup>3</sup>	0.25g/10min	>20 min@200°C
Borealis	Boresafe HE3492LS-H	Orange	RAL 2003	951 kg/m <sup>3</sup>	0.27g/10min	>20 min@200°C
Borealis	Boresafe HE3497LS-H	Red Brown	RAL 8012	956 kg/m <sup>3</sup>	0.3g/10min	-
Borouge	Boresafe HE3490LS-H	Black	RAL 9011	960 kg/m <sup>3</sup>	0.25g/10min	≥20 min@210°C
Borouge	Boresafe HE3492LS-H	Orange	RAL 2003	951 kg/m <sup>3</sup>	0.25g/10min	>20 min@200°C
Sabic	P6006RC Black	Black	-	959 kg/m <sup>3</sup>	0.23g/10min	≥30 min@210°C
Total	XSC20 B	Black	-	958 kg/m <sup>3</sup>	0.3g/10min	≥30 min@210°C
Total	XSC50 Orange	Orange	-	950 kg/m <sup>3</sup>	0.3g/10min	≥30 min@210°C
LyondellBasell	Hostalen CRP100 RESIST CR Black	Black	RAL 9004	958 kg/m <sup>3</sup>	0.23g/10min	≥30 min@210°C
LyondellBasell	Hostalen CRP100 RESIST CR Orange	Orange	RAL 1033	950 kg/m <sup>3</sup>	0.27g/10min	≥30 min@210°C
LyondellBasell	Hostalen CRP100 RESIST S Brown	Red Brown	RAL 8023	958 kg/m <sup>3</sup>	0.23g/10min	≥20 min@210°C
Ineos	Eltex TUB 121N6000	Black	-	959 kg/m <sup>3</sup>	0.3g/10min	≥20 min@210°C
Ineos	Eltex TUB 125N6000	Orange	-	952 kg/m <sup>3</sup>	0.3g/10min	≥20 min@210°C
Genos	Alkadyne HCR193B	Black	-	959 kg/m <sup>3</sup>	0.2g/10min	≥30 min@210°C

*Mill-Pro uses only 100% virgin, Pre-Pigmented and Pre-Compounded raw materials, complying to BS EN 12201-1 for its pipe and fitting products.*

*Mill-Pro does not manufacture PE 80 pipe or use any recycled materials in the manufacture of any of our products, although our products are 100% end of life recyclable.*

*Mill-Pro E (Extreme) pipes are manufactured using only 100% virgin PE100 RC compounds. CCTV inner colour, black pipe body and all striping materials are all pre pigmented, certified PE100 RC compounds.*

*Some manufacturers use non-compliant linear low-density striping compounds during pipe manufacture. These are not PE100 RC compounds.*

*Incompatibility with the PE100 RC and couplers can lead to leaking along the stripe path when the pipes are joined using electrofusion couplers. Refer [here](#) for more information on these risks.*

## M90SE Brown Stripe / SN24 / SDR17 / Sewer pipes

M90SE Pipe – Two colour PE100 RC pipes, manufactured to BS EN 12201-2, with a 15% inner CCTV inspection assistance layer. Red Brown single striping, indicating a gravity sewer application. Pipes are extruded using the same PE100 RC base compounds for the pipe body, inner CCTV colour and indication striping. This ensures a single homogeneous pipe is extruded, eliminating electrofusion leak issues associated with using non PE100 RC striping compounds.

**M90S Pipe** – Manufactured from PE100+ compound (Not using PE100 RC) are only manufactured by special order to the same dimensions given below.

**INDICATION STRIPING** – PE100 RC Red Brown (RAL 8012) coloured stripes, indicating gravity Sewer.

Product code	DSD Equivalent Size	Nominal Outside Diameter (dn)	Mean Outside Diameter $d_{em}$		Maximum Out-of-roundness (ovality)	SDR17 / SN24 / PN10			Availability in Hong Kong
			Min.	Max.		Wall ( $e_m$ )	ID	Kg/m	
						Mean	Mean	Mean	
P1Q54.102.110	DN 100	110	110	110.7	2.2	7.0	96.4	2.2	Ex-Stock
P1Q54.102.160	DN 150	160	160	161.0	3.2	10.1	140.4	4.6	Ex-Stock
P1Q54.102.225	DN 200	225	225	226.4	4.5	14.2	197.4	9.0	Ex-Stock
P1Q54.102.250	DN 225	250	250	251.5	5.0	15.6	219.6	11.1	Ex-Stock
P1Q54.102.280	DN 250	280	280	281.7	9.8	17.5	245.9	13.9	Ex-Stock
P1Q54.102.355	DN 300	355	355	357.2	12.5	22.3	311.6	22.4	Ex-Stock
P1Q54.102.400	DN 375	400	400	402.4	14.0	25.0	351.3	28.3	Ex-Stock
P1Q54.102.450	DN 400	450	450	452.7	15.6	28.1	395.2	35.8	Ex-Stock
P1Q54.102.500	DN 450	500	500	503.0	17.5	31.2	439.2	44.2	Ex-Stock
P1Q54.102.560	DN 500	560	560	563.4	19.6	35.0	491.8	55.5	Ex-Stock
P1Q54.102.630	DN 525	630	630	633.8	22.1	39.3	553.4	70.1	Ex-Stock
P1Q54.102.710	DN 600	710	710	716.4	24.9	44.3	624.6	89.3	Ex-Stock
P1Q54.102.800	DN 675	800	800	807.2	28.0	49.9	703.9	113.2	Ex-Stock
P1Q54.102.900	DN 825	900	900	908.1	31.5	56.3	791.6	143.7	Contact us
P1Q54.102.1000	DN 900	1000	1000	1009.0	35.0	62.4	879.8	177.1	Contact us
P1Q54.102.1200	DN 1050	1200	1200	1210.8	42.0	74.2	1057.1	252.8	Contact us
P1Q54.102.1400	DN 1200	1400	1400	1412.6	49.0	86.6	1233.2	344.3	Contact us
P1Q54.102.1600	DN 1350	1600	1600	1614.4	56.0	98.9	1409.4	449.6	Contact us

**Note:**

1. Gravity Sewer pipes are generally always stocked to DN600, non-standard orders may be subject to Minimum Order Quantities (approx 400m), *Contact us* for more information.
2. All pipes listed with product codes are supplied in straight 5.80m lengths, Contact us for custom lengths up to 11.8m.



## M90SE Green Stripe / SN24 / SDR17 / Stormwater pipe

**M90SE Pipe** – Two colour PE100 RC pipes, manufactured to BS EN 12201-2, with a 15% inner CCTV inspection assistance layer. Fern green single striping, indicating a gravity stormwater application. Pipes are extruded using the same PE100 RC base compounds for the pipe body, inner CCTV colour and indication striping. This ensures a single homogeneous pipe is extruded, eliminating electrofusion leak issues associated with using non-PE100 RC striping compounds.

**M90S Pipe** – Manufactured from PE100+ compound (Not using PE100 RC) are only manufactured by special order to the same dimensions given below.

**INDICATION STRIPING** – PE100 RC Fern Green (RAL 6025) coloured stripes indicating gravity stormwater.

Product code	DSD Equivalent	Nominal Outside Diameter (dn)	Mean Outside Diameter $d_{em}$		Maximum Out-of-roundness (ovality)	SDR17 / SN24 / PN10			Availability in Hong Kong
	Size		Min.	Max.		Wall ( $e_m$ )	ID	Kg/m	
	DN		DN/OD			Mean	Mean	Mean	
P1QG4.102.110	DN 100	110	110	110.7	2.2	7.0	96.4	2.2	Ex-Stock
P1QG4.102.160	DN 150	160	160	161.0	3.2	10.1	140.4	4.6	Ex-Stock
P1QG4.102.225	DN 200	225	225	226.4	4.5	14.2	197.4	9.0	Ex-Stock
P1QG4.102.250	DN 225	250	250	251.5	5.0	15.6	219.6	11.1	Ex-Stock
P1QG4.102.280	DN 250	280	280	281.7	9.8	17.5	245.9	13.9	Ex-Stock
P1QG4.102.355	DN 300	355	355	357.2	12.5	22.3	311.6	22.4	Ex-Stock
P1QG4.102.400	DN 375	400	400	402.4	14.0	25.0	351.3	28.3	Ex-Stock
P1QG4.102.450	DN 400	450	450	452.7	15.6	28.1	395.2	35.8	Ex-Stock
P1QG4.102.500	DN 450	500	500	503.0	17.5	31.2	439.2	44.2	Ex-Stock
P1QG4.102.560	DN 500	560	560	563.4	19.6	35.0	491.8	55.5	Ex-Stock
P1QG4.102.630	DN 525	630	630	633.8	22.1	39.3	553.4	70.1	Ex-Stock
P1QG4.102.710	DN 600	710	710	716.4	24.9	44.3	624.6	89.3	Ex-Stock
P1QG4.102.800	DN 675	800	800	807.2	28.0	49.9	703.9	113.2	8-12 Weeks
P1QG4.102.900	DN 825	900	900	908.1	31.5	56.3	791.6	143.7	Contact us
P1QG4.102.1000	DN 900	1000	1000	1009.0	35.0	62.4	879.8	177.1	Contact us
P1QG4.102.1200	DN 1050	1200	1200	1210.8	42.0	74.2	1057.1	252.8	Contact us
P1QG4.102.1400	DN 1200	1400	1400	1412.6	49.0	86.6	1233.2	344.3	Contact us
P1QG4.102.1600	DN 1350	1600	1600	1614.4	56.0	98.9	1409.4	449.6	Contact us

**Note:**

- Gravity Stormwater pipes are generally always stocked to DN600, non-standard orders may be subject to Minimum Order Quantities (approx 400m), *Contact us* for more information.
- All pipes listed with product codes are supplied in straight 5.80m lengths, *Contact us* for custom lengths up to 11.8m.

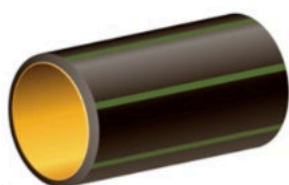



## M90SE Green / Brown Stripe / Other SN / SDR Ratings

### M90ES - PE100 RC Pipes available in other sizes and stiffness ratings (Green or Brown Stripe)

Below is a wider range of non-standard M90ES pipe sizes and stiffness ratings available from SN3 to SN100 that also comply with DSD Appendix 5A (for SN24 sizes see tables above) These pipes are manufactured using PE100 RC compounds unless ordered otherwise.

In addition, non-standard pipe sizes of any OD and SDR within the ranges given below, can be manufactured for relining & rehabilitation work, contact us for more information on the supply of non-standard size relining pipes.

Stiffness Rating PE100 RC				SN3 / PN5			SN6 / PN6.4			SN12 / PN8			SN50 / PN12.5			SN100 / PN16			
Nominal Diameter	Mean Outside Diameter (dem)		Max out-of-roundness (Ovality)	SDR33			SDR26			SDR21			SDR13.6			SDR11			
	min	max		Wall thickness	ID	kg/m	Wall thickness	ID	kg/m	Wall thickness	ID	kg/m	Wall thickness	ID	kg/m	Wall thickness	ID	kg/m	
DN / OD	min	max		Mean	Mean	Mean	Mean	Mean	Mean	Mean	Mean	Mean	Mean	Mean	Mean	Mean	Mean	Mean	
110	110	110.7	2.2	-	-	-	-	-	-	-	-	-	-	-	-	-	10.6	89.3	3.2
160	160	161.0	3.2	-	-	-	-	-	-	-	-	-	-	-	-	-	15.4	129.7	6.7
200	200	201.2	4.0	-	-	-	-	-	-	-	-	-	15.5	169.6	8.6	19.2	162.2	10.5	
225	225	226.4	4.5	-	-	-	-	-	-	-	-	-	17.5	190.7	11.0	21.6	182.5	13.3	
250	250	251.5	5.0	-	-	-	-	-	-	-	-	-	19.4	212.0	13.5	23.9	203.0	16.3	
280	280	281.7	9.8	-	-	-	-	-	-	-	-	-	21.7	237.5	16.9	26.8	227.4	20.5	
355	355	357.2	12.5	-	-	-	-	-	-	17.8	320.5	18.1	27.5	301.1	27.2	33.9	288.3	32.9	
400	400	402.4	14.0	-	-	-	16.2	368.9	18.7	20.2	360.9	23.1	31.0	339.3	34.5	38.2	324.8	41.8	
450	450	452.7	15.6	-	-	-	18.2	415.1	23.7	22.7	406.1	29.3	34.9	381.7	43.7	43.0	365.4	52.9	
500	500	503.0	17.5	-	-	-	20.2	461.2	29.2	25.2	451.2	36.1	38.7	424.1	54.0	47.8	406.0	65.3	
560	560	563.4	19.6	-	-	-	22.6	516.6	36.6	28.1	505.5	45.2	43.4	475.0	67.7	53.4	454.9	81.8	
630	630	633.8	22.1	-	-	-	25.4	581.1	46.4	31.6	568.8	57.1	48.7	534.5	85.6	60.2	511.6	103.7	
710	710	716.4	24.9	23.0	667.3	47.7	28.7	655.9	59.1	35.7	641.9	72.8	54.9	603.4	108.9	67.8	577.6	131.9	
800	800	807.2	28.0	25.8	752.0	60.5	32.2	739.2	74.9	40.1	723.4	92.3	61.8	680.0	138.2	76.3	651.0	167.3	
900	900	908.1	31.5	29.1	846.0	76.6	36.2	831.7	94.7	45.1	813.9	116.8	69.6	764.9	175.0	85.9	732.4	211.7	
1000	1000	1009.0	35.0	32.2	940.1	94.4	40.2	924.1	116.8	50.2	904.2	144.3	76.2	852.1	213.2	94.8	814.9	259.9	
1200	1200	1210.8	42.0	38.6	1128.2	135.7	48.3	1108.9	168.3	60.2	1085.1	207.6	92.7	1020.0	310.9	-	-	-	
1400	1400	1412.6	49.0	45.1	1316.1	185.0	56.0	1294.4	227.7	70.1	1266.2	282.1	108.1	1190.1	423.0	-	-	-	
1600	1600	1614.4	56.0	51.5	1504.2	241.5	64.5	1478.3	299.7	80.1	1447.1	368.5	123.6	1360.1	552.5	-	-	-	

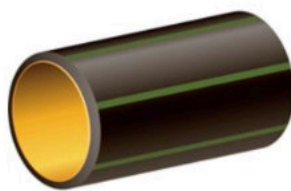





## Friatec Electrofusion Couplers

Mill-Pro partners with FRIATEC, part of the Aliaxis Group, to offer the world's leading electrofusion (EF) couplers and fittings.

Founded in 1863, Friatec developed the world's first electrofusion couplers in 1979 for joining PE gas pipes. Friatec remains the world leader in electro-fusion fittings for water, wastewater and gas.

The Frialen product range has an outstanding reputation in Hong Kong since 2006. Friatec couplers have the lowest failures rates, both short and long term when compared to any other coupler available in Hong Kong, by a significant margin. A recent project in Hong Kong installed ~2000pcs of 400 OD couplers, less than 0.2% of the couplers failed during testing (failures due to either product or installation problems), this compares with our competitor's failure rates of up to 20%. These reliability rates save contractors significant cost.

From their world-class automated manufacturing facilities in Mannheim Germany, Friatec offers the worlds largest range of electrofusion fittings, tools, accessories and welding machines to provide a complete electro-fusion solution for joining PE Pipes and fittings.



*Product specifications and dimensions are subject to change without notice.*

*For the latest information refer to our website: [www.millpro.com.hk](http://www.millpro.com.hk) or contact our [sales team](#).*



*This mark is used to identify Mill-Pro products that meet the requirements of the Drainage Supplies Department PS Appendix 22.09. The use of this mark is not endorsed by the DSD and is not intended to infer approval by the DSD.*

## Black Couplers / AM / PN10 / SDR17

Friatec's Frialen PE100 AM black couplers are suitable for fusing pipes from SDR17 to SDR26. AM couplers feature large insertion depth for pipe stability during fusion (no holding clamps required) and extra-wide fusion and cold zones for maximum melt containment. Exposed heating coils for direct heat transmission to the pipe and a small annular gap ensure optimum joining pressure in the fusion zone.

A visual pop up fusion indicator confirms weld pressure and traceability bar codes are included for recording batch GIS and BIM records for each coupler installed. All couplers are sealed in individual plastic bags for protection on site.

NOTE: The pipe or spigot ends and the coupler must be prepared in accordance with the *general installation instructions* using a *spigot mechanical peeler*, *90% Isopropyl alcohol wipes* and we recommend using the *Friamat fusion control unit* for logging the full range of weld data available.

Frialen AM Electrofusion couplers are made in Germany.

Product Code	dn	D	L	L1	Availability in Hong Kong
P3314.200.110	110	130	160	80	Ex-Stock
P3314.200.160	160	184	180	90	Ex-Stock
P3314.200.225	225	263	200	100	Ex-Stock
P3314.200.250	250	282	220	110	Ex-Stock
P3314.200.280	280	316	220	110	Ex-Stock

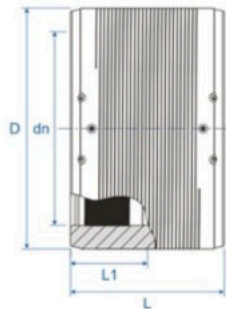



## Black Couplers / UB / PN10 / SDR17

Friatec's Frialen PE100 UB17 black couplers are suitable for fusing pipes from SDR17 to SDR26. UB couplers feature large insertion depth for pipe stability during fusion (no holding clamps required) and extra-wide fusion and cold zones for maximum melt containment. Exposed heating coils for direct heat transmission to the pipe and a small annular gap ensure optimum joining pressure in the fusion zone.

UB17 coupler sizes  $dn \geq 560$  include a barcode PREHEAT function to warm the pipe and coupler to help re-round oval pipes and close the fusion gap prior to welding. From  $dn \geq 355$  UB17's feature, permanent external reinforcement wound into the body of the coupler to ensure the coupler does not expand during the fusing process.

*Couplers that are not injection moulded and do not have external reinforcement are likely to expand during fusion. Coupler expansion increases the gap between the pipe and coupler, which reduces weld pressure in the joint. This leads to slow crack growth failure through the weld plane. Slow Crack Growth, by its name, is slow and occurs over time (1-5 years), well beyond the joint successfully passing hydrostatic testing on site. DSD Appendix 5A Clause 5.6.13, requires non-injection moulded couplers to have a suitable form of external reinforcement to prevent expansion applied to the coupler as parts of it's manufacture.*

NOTE: The pipe or spigot ends and the coupler must be prepared in accordance with the *general installation instructions* using a spigot mechanical peeler, 90% Isopropyl alcohol wipes and we recommend using the *Friamat fusion control unit* for logging the full range of weld data available. For  $\geq d1000$  UB17 couplers, the *Friamat XL fusion control unit* must be used.

Frialen UB17 Electrofusion couplers are made in Germany.

Product Code	dn	D	L	L1	L2	Availability in Hong Kong
P3314.100.355	355	400	290	145	70	Ex-Stock
P3314.100.400	400	450	300	150	78	Ex-Stock
P3314.100.450	450	506	320	160	87	8-12 Weeks
P3314.100.500	500	562	350	175	85	Ex-Stock
P3314.098.560	560	630	380	190	77	Ex-Stock
P3314.098.630	630	710	420	210	101	Ex-Stock
P3314.098.710	710	800	442	221	112	Ex-Stock
P3314.098.800	800	900	500	250	137	Ex-Stock
P3314.098.900	900	1024	500	250	110	8-12 Weeks
P3314.098.1000	1000	1130	610	305	129	8-12 Weeks
P3314.098.1200	1200	1356	670	335	155	8-12 Weeks

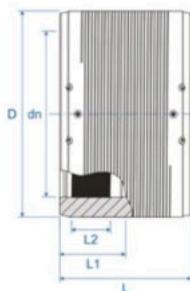



## Manhole Connectors for Polyethylene Pipes

Manhole Connectors fix PE pipes into Concrete chamber walls. A connector is necessary because, unlike rigid Ductile Iron or Clay pipes, PE pipes are subject to ongoing movement through temperature change and ground settlement. This causes small but constant changes in pipe length. This combined with expansion of the pipe OD as the concrete cures, means there is always a gap between the concrete and the pipe. If a manhole connector is not used, sewage and waste water will continuously leak from the chamber, polluting ground water, leading to erosion and sinkage.

### Type A / Flexible Connection

Also known as a Sliding Manhole Joint, this comprises of two machined PE components, independent of each other. The socket ring is plastered into the concrete chamber (non structural) and the spigot fused onto the PE pipe. The two components seal with O'rings and a hydrophilic expansion seal. This joint allows the pipe and spigot to move independently of the Socket ring in the chamber.

Movement due to temperature change (thermal movement) and settlement forces causing small changes in the pipes length or angle, are not transferred into the chamber wall. These Socket/Spigot type joints allow for some vertical deflection ( $\leq 3^\circ$ ), so the chamber and pipe can settle independently of each other, the pipe can change in length due to temperature, while still maintaining a water tight joint with up to 5m of head. Typically only used in sizes up to DN525, larger sizes a Rigid Type B joint is typically used.

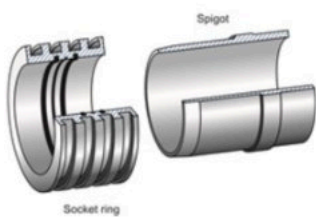

Flexible Manhole Connector (Fabricated)



Flexible Manhole Connector (Friatec)

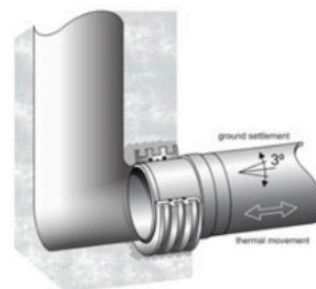

Flexible Manhole Connector Installation

Product specifications and dimensions are subject to change without notice.

For the latest information refer to our website: [www.millpro.com.hk](http://www.millpro.com.hk) or contact our [sales team](#).



This mark is used to identify Mill-Pro products that meet the requirements of the Drainage Supplies Department PS Appendix 22.09. The use of this mark is not endorsed by the DSD and is not intended to infer approval by the DSD.



## Advantages and limitations of Type A

**Advantages of Type A connections** – In a Type A joint, the spigot end is welded to the pipe. When movement caused by a temperature change in the fluids, traffic loading or soil movement is applied, the spigot can slide a small amount inside the socket's rubber rings, but still maintain a watertight seal.

This flexible design means no force is applied to the socket ring or the chamber wall from pipe movement, therefore the socket ring can simply be plastered into a hole in the chamber wall (non structural install). The socket ring does not need to be tied in with reinforcing or poured with the wall, as there are no forces applied to the socket ring by the pipes movement.

Type A Flexible joints are quick to install as no structural concrete / reinforcement / corbels are required. A hole is made in an existing cast chamber wall and the socket ring plastered in, as the pipe is laid.

**Limitations of Type A connections** – Type A joints are not suitable in reclaimed land, as change in the length of the pipe due to ground settlement will be greater than the spigot length, also not suitable if all or part of the pipe is above ground, as large temperature changes may generate significant length change in the pipe, both situations could pull the spigot out of the socket ring over time. Not recommended for installations where there is steep gradient between chambers (down a slope).

In the cases above, a Type B rigid joint should be cast into the chamber wall, integrated with the reinforcing, to create a structurally anchored connection. This anchors the pipe ends into the chambers and settlement is taken up in the pipe, which self relaxes when ground movement or settlement occurs.

## Type B / Rigid connection / Single or Double Spigot

Using the same principal and dimension relationships as a PE puddle flange, a Type B rigid manhole joint is machined from a single piece of hollow PE100 bar, with an embedded hydrophilic seal ring on the puddle edge. The theory of anchoring PE using puddle flanges is given here. The principal is that under tensile stress, the pipe will fail before the puddle pulls free of the concrete. Type B joints must be used in reclaimed land where future ground settlement will slowly stretch the pipe between chambers.

Type B joints should be wrapped with 6-10mm thick insertion rubber, at the PE-Concrete interface during pouring of the chamber, to protect the PE from point loading on the concrete edge during deflection.

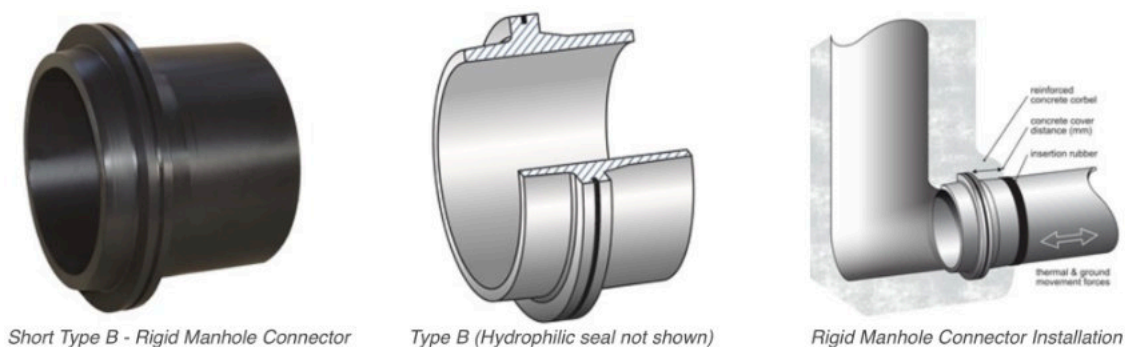

## Advantages and Limitations of Type B

**Advantages of Type B connections** – Type B joints are typically cast into the chamber wall (not plastered in place like Type A) and when integrated with reinforcing steel and have sufficient cover, can withstand 100% of the maximum tensile force applied by the pipe. Type B connections are designed for reclaimed land, steep slopes, or where the pipe is installed above ground. Type B / Double Spigot series can be cast into the wall on an Angle up to 30° and the excess spigot cut off after cured in place, saving repair plastering inside the chamber.

**Limitations of Type B connections** – Because they are a rigid connection, the forces created by temperature change in the pipe (length change) are transmitted directly into the chamber wall. Therefore, Type B connections should to be cast into the wall when the chamber is poured. In addition, the chamber wall must have sufficient cover over the puddle flange to transfer the tensile forces into the wall and back against the soil face. This may add construction expense and means the PE pipe installation must be performed during chamber construction, unlike a Type A connection.

## DSD Type A / Flexible Manhole connection

Mill-Pro supplies the Friatec PE100 Electrofusion Sliding Manhole connector comprising of two components. The Electrofusion spigot (AEM) end that fuses to the pipe and a socket end (ASF) that is plastered into the manhole chamber wall. The spigot features 2 x NBR sealing O-Rings and an expanding hydrophilic sealing ring between the sealing rings.

**Each component is sold separately, BOTH are required to complete a joint.**

### AEM / Electrofusion Insert Sleeve

Product Code	Connection DN	PE OD dn	Spigot OD (D)	L	Insertion length (L1)	Availability in Hong Kong
P3310.010.110	100	110	133	165	135	8-12 weeks
P3310.010.160	150	160	193	225	135	Ex-Stock
P3310.010.225	200	225	280	220	135	Ex-Stock
P3310.010.250	225	250	280	220	135	Ex-Stock
P3310.010.280	250	280	315	220	135	Ex-Stock
P3310.010.355	300	355	400	220	135	Ex-Stock
P3310.010.400	375	400	450	220	135	Ex-Stock
P3310.010.450	400	450	500	220	135	Ex-Stock
P3310.010.560	500	560	630	220	135	Ex-Stock
P3310.010.630	525	630	710	220	135	Ex-Stock

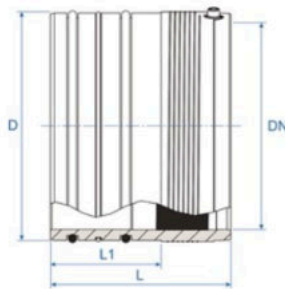



## ASF / Cast in Chamber ring

Product Code	Connection DN	PE OD dn	Socket Ring OD (D)	Socket Ring ID (d)	L	Availability in Hong Kong
P0310.011.110	100	110	200	134	135	8-12 weeks
P0310.011.160	150	160	250	190	135	Ex-Stock
P0310.T11.225-250	200/225	225 & 250	335	280	135	Ex-Stock
P0310.011.280	250	280	400	316	135	Ex-Stock
P0310.T11.355	300	355	470	402	135	Ex-Stock
P0310.011.400	375	400	560	452	135	Ex-Stock
P0310.011.450	400	450	630	502	135	Ex-Stock
P0310.011.560	500	560	710	628	135	Ex-Stock
P0310.011.630	525	630	800	713	135	Ex-Stock

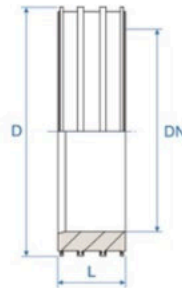

## ASFL / Sewage inspection chamber adaptor for masoned canals

Product Code	DN	dn	D	d1	L	Availability in Hong Kong
P0310.041.225250	200/225	225 & 250	355	280	250	8-12 weeks
P0310.041.280	250	280	400	316	250	8-12 weeks
P0310.041.355	300	355	500	402	250	8-12 weeks
P0310.041.450	400	450	630	502	250	8-12 weeks
P0310.041.560	500	560	710	628	250	8-12 weeks
P0310.041.630	525	630	800	713	250	8-12 weeks

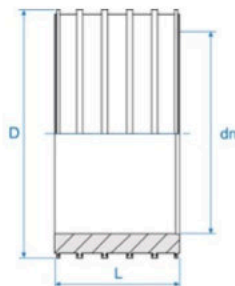

## Type B / Rigid Manhole Connector / Single Spigot / SDR17 / Long Spigot

The Type-B rigid manhole connector Single Spigot is designed to be cast flush against the internal chamber wall. Installed up against the internal formwork during chamber construction with the outlet approximately between 80-100° to the chamber wall.

Machined from PE100 hollow bar, this fitting includes a hydrophilic sealing ring in the outer edge of the puddle, sealed for exposure on site. Supplied in Long Spigot (LS) design for electrofusion joining on site and sizes DN800 and above are supplied for butt welding.

Product Code	Pipe OD	Connection size	Wall thickness	Puddle thickness	Puddle OD	Taper	Spigot length	Length	Availability in Hong Kong
SDR17 SN24	dn	DN	t	W	D4	L3	le	Z	
P531E.143.110	110	100	6.6	20	138	50	150	270	6-8 weeks
P531E.143.160	160	150	9.5	20	200	50	150	270	6-8 weeks
P531E.143.200	200	175	11.9	20	250	50	150	270	6-8 weeks
P531E.143.225	225	200	13.4	20	282	50	150	270	6-8 weeks
P531E.143.250	250	225	14.8	20	313	50	250	370	Ex-stock
P531E.143.280	280	250	16.6	21	350	50	250	371	6-8 weeks
P531E.143.355	355	300	21.1	27	444	54	300	435	Ex-stock
P531E.143.400	400	375	23.7	30	500	60	300	450	6-8 weeks
P531E.143.450	450	400	26.7	34	563	68	300	470	6-8 weeks
P531E.143.500	500	560	29.7	37	625	74	350	535	6-8 weeks
P531E.143.560	560	500	33.2	42	700	84	350	560	6-8 weeks
P531E.143.630	630	525	37.4	47	788	94	350	585	6-8 weeks
P531E.143.710	710	600	42.1	53	888	106	350	615	6-8 weeks
P531E.143.800	800	675	47.4	59	1000	118	350	645	6-8 weeks

\*SDR21  
\*\*SDR26

## Type B / Rigid Manhole Connector / Single Spigot / Butt Fusion

Product Code	Pipe OD	Connection size	Wall thickness	Puddle thickness	Puddle OD	Taper	Spigot length	Length	Availability in Hong Kong
SDR17 SN24	dn	DN	t	W	D4	L3	le	Z	
P231E.143.900	900	825	53.3	67	1045	134	100	435	6-8 weeks
P231E.143.1000	1000	900	59.3	74	1161	148	100	470	6-8 weeks
P231E.143.1200	1200	1050	71.1	89	1393	178	100	545	6-8 weeks
P231D.143.1300	1300	1200	62.1*	78	1474	156	100	490	6-8 weeks
P231D.143.1400	1400	1300	66.7*	84	1587	168	100	520	6-8 weeks
P231D.143.1600	1600	1350	76.2*	96	1813	192	100	580	6-8 weeks
P231C.143.1800	1800	1650	68.8**	87	1998	174	100	535	6-8 weeks
P231C.143.2000	2000	1800	76.4**	96	2220	194	100	584	6-8 weeks

\*SDR21  
\*\*SDR26

**Note:** Hydrophilic sealing ring is not fitted in the picture below.

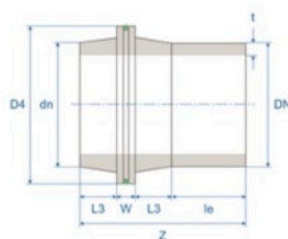

## Type B / Rigid Manhole Connector / Double Spigot

This connector is designed to be cast into a chamber wall on an angle between 60°-120° to the chamber wall. Post curing the extending internal spigot end can be cut flush with the inside of the chamber wall. This eliminates significant internal shuttering during pouring and clean up plastering - see image below as an example of typical use.

For connections where the manhole connector is almost perpendicular to the chamber wall use a Type B / Rigid / Single Spigot connector.



Long Type B

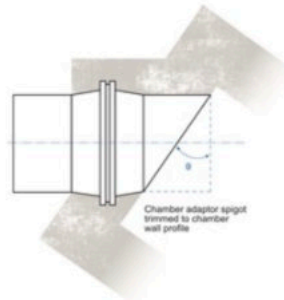

Angled Encasement

dn	Spigot Length	Max Angle θ
225	150mm	22°
250	250mm	33°
280	280mm	32°
355	300mm	32°
450	300mm	29°
500	350mm	33°
560	350mm	32°

Specifications

## Type B / Manhole Connector / Double Spigot / SDR17

Machined from PE100 hollow bar, this fitting includes a hydrophilic sealing ring in the outer edge of the puddle, sealed for exposure on site. Supplied in Long Spigot (LS) design for electrofusion joining on site and sizes DN800 and above are supplied for butt welding.

Product code	Pipe OD	Connection size	Wall thickness	Puddle thickness	Shank OD	Puddle OD	Taper	Spigot Length	Length	Availability in Hong Kong
<b>SDR17 SN24</b>	dn	DN	t	W	D5	D4	L3	le	Z	
P5314.938.110	110	100	6.6	20	125	138	50	150	420	6-8 weeks
P5314.938.160	160	150	9.5	20	175	200	50	150	420	6-8 weeks
P5314.938.200	200	175	11.9	20	232	250	50	150	420	6-8 weeks
P5314.938.225	225	200	13.4	20	235	282	50	150	420	6-8 weeks
P5314.938.250	250	225	14.8	20	285	313	50	250	620	6-8 weeks
P5314.938.280	280	250	16.6	21	291	350	50	250	621	6-8 weeks
P5314.938.355	355	300	21.1	27	373	444	54	300	735	6-8 weeks
P5314.938.400	400	375	23.7	30	427	500	60	300	750	6-8 weeks
P5314.938.450	450	400	26.7	34	470	563	68	300	770	6-8 weeks
P5314.938.500	500	560	29.7	37	530	625	74	350	885	6-8 weeks
P5314.938.560	560	500	33.2	42	585	700	84	350	910	6-8 weeks
P5314.938.630	630	525	37.4	47	642	788	94	350	935	6-8 weeks
P5314.938.710	710	600	42.1	53	737	888	106	350	965	6-8 weeks
P5314.938.800	800	675	47.4	59	840	1000	118	350	995	6-8 weeks

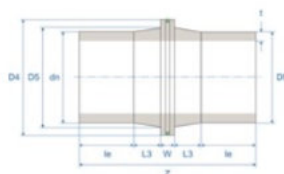



## Type B / Manhole Connector / Double Spigot / BF / SDR17

Product code	Pipe OD	Connection size	Wall thickness	Puddle thickness	Shank OD	Puddle OD	Taper	Spigot length	Length	Availability in Hong Kong
<b>SDR17 SN24</b>	dn	DN	t	W	D5	D4	L3	le	Z	
P2314.938.900	900	825	53.3	67	944	1045	134	100	535	6-8 weeks
P2314.938.1000	1000	900	59.3	74	1047	1161	148	100	570	6-8 weeks
P2314.938.1200	1200	1050	71.1	89	1245	1393	178	100	645	6-8 weeks

## Type B / Manhole Connector / Double Spigot / BF / SDR21

Product code	Pipe OD	Connection size	Wall thickness	Puddle thickness	Shank OD	Puddle OD	Taper	Spigot length	Length	Availability in Hong Kong
<b>SDR21 SN12</b>	dn	DN	t	W	D5	D4	L3	le	Z	
P2313.938.1300	1300	1200	62.1	78	1340	1474	156	100	590	6-8 weeks
P2313.938.1400	1400	1300	66.7	84	1445	1587	168	100	620	6-8 weeks
P2313.938.1600	1600	1350	76.2	96	1650	1813	192	100	680	6-8 weeks

## Type B / Manhole Connector / Double Spigot / BF / SDR26

Product code	Pipe OD	Connection size	Wall thickness	Puddle thickness	Shank OD	Puddle OD	Taper	Spigot Length	Length	Availability in Hong Kong
<b>SDR26 SN6</b>	dn	DN	t	W	D5	D4	L3	le	Z	
P2312.938.1800	1800	1650	68.8	86	1855	1998	174	100	634	6-8 weeks
P2312.938.2000	2000	1800	76.4	96	2060	2220	194	100	684	6-8 weeks

Note: Above OD 800 Joints are supplied with fusion weld ends for factory joining to pipe, long spigots available on request.

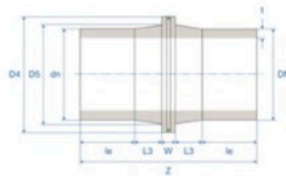

Note: Hydrophilic sealing ring is not fitted in the picture above.



## Transitions and Adapters

Polyethylene 'Transition' or 'Adapter' fittings are used to connect PE gravity drainage pipe to another pipe material, such as: Ductile or Cast Iron, PVC, VCP (Clay), RCP (Reinforced concrete pipe). Transitions are typically a PE socket end with a rubber ring joint that slides over an adjoining pipe spigot end.

**Manufacture** - Transitions are machined from a single piece of PE100 PE hollow bar and include an integrated puddle flange. The puddle (when encased in Concrete) anchors the transition joint to the existing pipe material. This prevents changes in temperature and ground movement pulling the PE and transition RRJ socket off the existing pipe end.

**Concentric vs. Eccentric Transitions** - The difference in Inside diameters between the existing pipe and the PE pipe determines if the transition design must be Concentric or Eccentric. DSD states that Eccentric designs must be used where the internal diameters between the PE and joining pipe differ by  $\geq 5\%$ . This maintains a free draining level invert inside the pipe, avoiding an internal steps that cause septic pooling.

DSD PS Appendix 5A

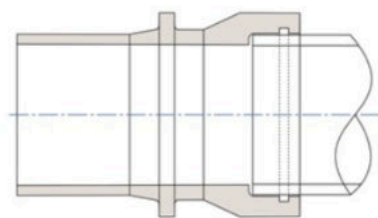

*Concentric Design - Example: DN300 PE is 355 OD SDR 17 which has 311mm ID, this is connecting to a DN 300 CI fitting with an 316mm ID. So  $316/311 = 1.6\%$ , which is  $< 5\%$ , so Concentric design is OK.*

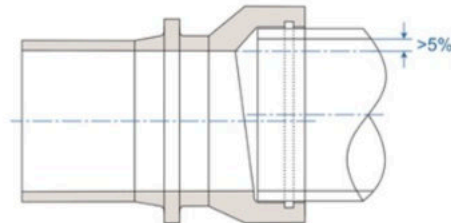

*Eccentric Design - Example: DN150 PE is 160 OD SDR17 which has a 140mm ID, this is connecting to a DN150 CI fitting with an ID of 152mm ID. So  $152/140 = 8.5\%$ , which is  $>5\%$  so the transition must be Eccentric.*



Preparation & measuring of DI Spigot



Installation of Transition c/w Puddle flange



Pipe fused to transition, ready for encasement

Product specifications and dimensions are subject to change without notice.

For the latest information refer to our website: [www.millpro.com.hk](http://www.millpro.com.hk) or contact our [sales team](#).

## Transition for adapting Cast Iron P-Trap spigot to PE pipe

Where existing Cast Iron P-Traps are connected to PE pipe, a Rubber Ring joint (RRJ) Transition adapter is required to make a leak tight connection. The transition adapter will be either Eccentric or Concentric in design, depending on the PE pipe size connecting to the P-Trap. Eccentric connectors ensure the level invert is maintained and no septic pooling of wastewater or blockage step exists at the joint between the PE and cast iron.

Recommendations for anchoring the RRJ transition socket to the P-Trap / Chamber wall are given below, two possible conditions are considered:

**Option 1:** Normal Condition - Where there are no significant ground or thermal forces acting on the pipe. The pipe is buried and installation is not in reclaimed land or on a significant slope.

**Option 2:** Special Condition - Where ground movement is expected, such as installation in reclaimed land, installation on a steep slope, installed above ground or where the pipe is subject to significant thermal forces.

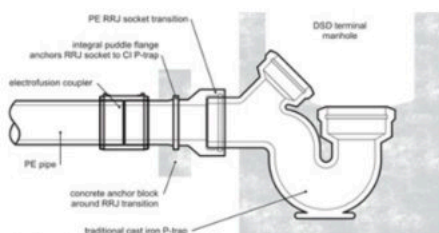

*Option 1: 90% of cases - Pour a simple concrete anchor block around the puddle flange on the adapter, backfill with soil and compact. Use this method unless special installation conditions given in Option 2 exist.*

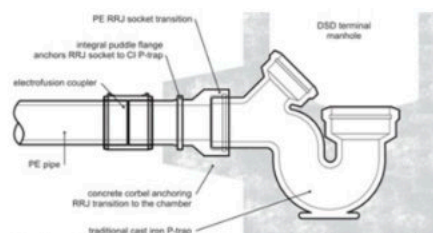

*Option 2: Special Conditions - Required in reclaimed ground, when installation gradient is steep, pipe is installed above ground... any situation that transfers significant pulling forces to the RRJ socket. Pour an integrated Corbel with the chamber wall around the adapter.*

## PE to Cast Iron Transition (P-Trap) / Spigot / Socket / SDR 17

PE100 Single piece transition adapters, machined from Hollow bar with integrated puddle flange and supplied with a BS EN 681-1 NBR (or equivalent) rubber sealing ring. Sockets can be machined to order once the actual Cast Iron spigot diameter is known.

The design of the transition is Eccentric if the ID of the PE pipe (SDR17) and the ID of the CI fitting is greater than 5% difference. Eccentric design avoids an internal step.

Product Code	DI Pipe Nb	Pipe OD dn / DN	Fitting rating SDR	Type	Long Spigot Length L2	LS Length Z1	Availability in Hong Kong
P531E.055.160160	150 CI EN877	160	17	Eccentric	150	384	4-6 weeks
P531E.045.225222	200 DI EN598	225	17	Eccentric	150	395	Ex-Stock
P531E.050.250247	225 CI	250	17	Concentric	250	473	Ex-Stock
P531E.055.280274	250 CI EN877	280	17	Eccentric	250	508	4-6 weeks
P531E.050.355326	300 CI EN877	355	17	Concentric	300	521	4-6 weeks
P531E.043.400378	350 DI EN598	400	17	Concentric	300	568	4-6 weeks
P531E.055.400403	375 CI	400	17	Eccentric	300	624	4-6 weeks
P531E.055.450429	400 CI EN877	450	17	Eccentric	300	614	4-6 weeks
P531E.045.500480	450 DI EN598	500	17	Eccentric	300	621	4-6 weeks
P531E.050.710635	600 CI EN877	710	17	Concentric	300	675	4-6 weeks

**Note:** CI P-Traps vary from manufacturer to manufacturer. The OD of the cast iron spigot must be confirmed before ordering.

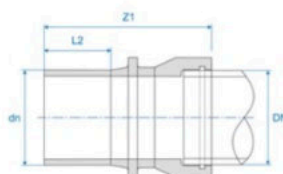

Concentric design type

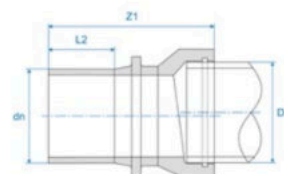

Eccentric design type





## Terminal Manhole Connection / P-Trap

Typically referred to as a P-trap, this is a fully structural fabricated polyethylene equivalent, to a traditional cast iron P-trap. It shares similar dimensions to traditional cast iron P-Traps.

P-traps are installed at the base of terminal manholes to prevent sewer gas (H<sub>2</sub>SO<sub>4</sub>) and odours escaping from the manhole (such as the last manhole inside buildings). PE P-Trap's have an expected life of 100 years. Cast Iron P-Traps need replacing after 15-20 years of service due to internal corrosion.

Mill-Pro PE P-Traps are supplied with a rubber ring sealed PE plug at the rodding eye inlet, chain loop and a stainless steel chain/wire connection to fix the plug to the chamber wall.

When PE is cast into concrete there's no adhesion between PE and cement. Due to thermal expansion of the PE during concrete curing, there is a small gap between the PE and the cured concrete after cooling. This gap allows wastewater to leak past the PE fitting. A Hydrophilic seal is fitted where the PE exits the concrete, this seal expands up to 600% when wet to seal the PE and concrete chamber walls.

### Polyethylene P-trap installation

Mill-Pro polyethylene P-Traps require no anchoring as the connecting PE pipe is electrofused directly to the spigot of the polyethylene P-Trap, which is cast into the manhole chamber. The P-Trap can take full tensile load once cast into the chamber wall. This is the lowest cost option for a terminal manhole and provides a maintenance free drainage system.

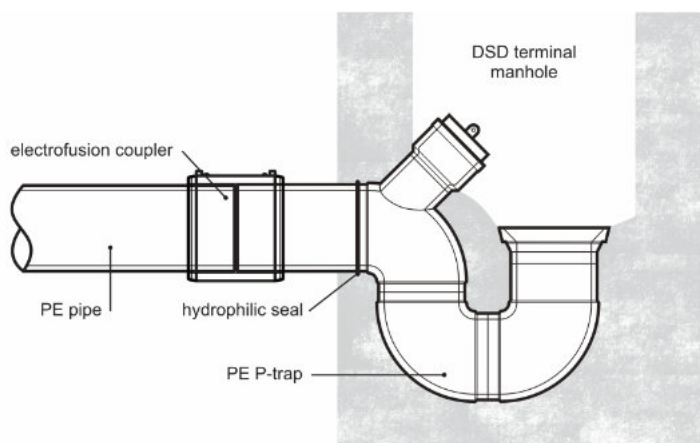

**Product specifications and dimensions** are subject to change without notice.

For the latest information refer to our website: [www.millpro.com.hk](http://www.millpro.com.hk) or contact our sales team.



*This mark is used to identify Mill-Pro products that meet the requirements of the Drainage Supplies Department PS Appendix 5A. The use of this mark is not endorsed by the DSD and is not intended to infer approval by the DSD.*

## Mill-Pro P-Trap / SDR17 / PE100

Fabricated using Butt welding techniques (no extrusion welding is used) from SDR 17 pipe & fittings, this P-Trap features a smooth bell mouth entry, no internal weld beads, a rodding arm with a PE plug and O-Rings, complying the the DSD requirements.

The entry bell mouth and exit spigot are fitted with Hydrophilic seals.

Product Code	NB	dn1	dn2	dn ID	le1	le2	L3	A	C	B	S	D1	Availability in Hong Kong
P531E.071.160110	DN150 x 100	160	110	140	150	164	254	436	266	150	135	210	6-8 weeks
P531E.071.225110	DN200 x 100	225	110	197	150	255	296	505	374	150	143	295	6-8 weeks
P531E.071.250160	DN225 x 150	250	160	219	250	271	413	542	420	150	156	328	6-8 weeks
P531E.071.280160	DN250 x 150	280	160	245	250	302	432	584	462	150	170	368	6-8 weeks
P531E.071.355160	DN300 x 150	355	160	311	300	472	531	687	633	150	203	435	6-8 weeks
P531E.071.400160	DN350 x 150	400	160	351	300	533	560	735	706	150	208	490	6-8 weeks
P531E.071.450160	DN375 x 150	450	160	394	300	519	593	789	730	150	215	552	6-8 weeks
P531E.071.500160	DN450 x 150	500	160	438	350	571	675	943	800	150	322	613	6-8 weeks
P531E.071.560160	DN500 x 150	560	160	490	350	692	714	1007	926	150	330	687	6-8 weeks
P531E.071.630160	DN525 x 150	630	160	552	350	795	760	1113	1046	150	370	773	6-8 weeks

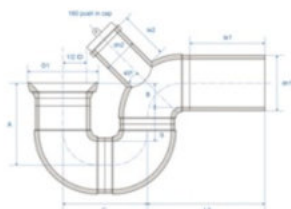



## Drops & Elbows (vertical)

Our typical gravity drainage assemblies used in manhole and building connections. These are commonly assemblies that are cast into manhole structures and used to control flows in chambers. Typically tight bends (elbows) are only used where there is a vertical or straight drop, therefore very limited risk of blockages occurring.

These assemblies are made to order and generally match the DSD standard drawings for manhole intake designs. Some dimensions in the tables are given as " $\geq$  xxx" meaning the dimension must be greater than or equal to the given number (this is the smallest dimension we can make). So designers and contractors can have the fitting tailored to suit their application at order placement.

All fittings are factory fabricated using butt welding standards that comply to DSD PS Appendix 5A, Clause 5.4.

*Product specifications and dimensions are subject to change without notice.*

*For the latest information refer to our website: [www.millpro.com.hk](http://www.millpro.com.hk) or contact our [sales team](#).*



*This mark is used to identify Mill-Pro products that meet the requirements of the Drainage Supplies Department PS Appendix 22.09. The use of this mark is not endorsed by the DSD and is not intended to infer approval by the DSD.*



## 45° Moulded Cleaning Eye Elbows / LS / Black / PN10 / SDR17

PE100+ long spigot elbows with factory butt fusion welded PE inspection port with screw cap and sealing gasket.

Product Code	dn1	dn2	le	r	z	Availability in Hong Kong
P531E.172.200110	200	110	112	88	147	8-10 weeks
P531E.172.225110	225	110	115	99	134	8-10 weeks
P531E.172.250110	250	110	129	110	162	8-10 weeks
P531E.172.280110	280	110	148	124	200	8-10 weeks
P531E.172.355110	355	110	*160	157	227	8-10 weeks
P531E.172.355160	355	160	*160	157	227	8-10 weeks
P531E.172.400110	400	110	*158	176	215	8-10 weeks
P531E.172.400160	400	160	*158	176	215	8-10 weeks
P531E.172.400200	400	200	*158	176	215	8-10 weeks
P531E.172.450110	450	110	*170	199	249	8-10 weeks
P531E.172.450160	450	160	*170	199	249	8-10 weeks
P531E.172.450200	450	200	*170	199	249	8-10 weeks
P531E.172.500110	500	110	*205	221	272	8-10 weeks
P531E.172.500160	500	160	*205	221	272	8-10 weeks
P531E.172.500200	500	200	*205	221	272	8-10 weeks
P531E.172.560110	560	110	*200	247	279	8-10 weeks
P531E.172.560160	560	160	*200	247	279	8-10 weeks
P531E.172.560200	560	200	*200	247	279	8-10 weeks
P531E.172.630110	630	110	*220	278	317	8-10 weeks
P531E.172.630160	630	160	*220	278	317	8-10 weeks
P531E.172.630200	630	200	*220	278	317	8-10 weeks

\* Spigot lengths suitable for Mill-Pro supplied PN10 EF couplers but shorter than L2 in BSEN 12201-3 table 3

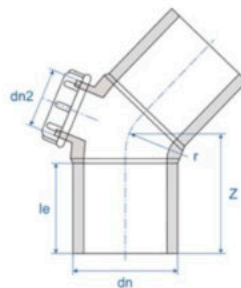

## 90° Moulded Cleaning Eye Elbows / LS / Black / PN10 / SDR17

90° PE100+ long spigot elbows with factory butt fusion welded PE inspection port with screw cap and sealing gasket.

Product Code	dn	dn2	le	r	z	Availability in Hong Kong
P531E.173.200110	200	110	125	88	239	8-10 weeks
P531E.173.225110	225	110	135	99	255	8-10 weeks
P531E.173.250110	250	110	130	110	265	8-10 weeks
P531E.173.280110	280	110	*135	124	282	8-10 weeks
P531E.173.355110	355	110	*155	157	365	8-10 weeks
P531E.173.355160	355	160	*155	157	365	8-10 weeks
P531E.173.450110	400	110	*145	176	378	8-10 weeks
P531E.173.450160	400	160	*145	176	378	8-10 weeks
P531E.173.450200	400	200	*145	176	378	8-10 weeks
P531E.173.500110	500	110	*210	221	460	8-10 weeks
P531E.173.500160	500	160	*210	221	460	8-10 weeks
P531E.173.500200	500	200	*210	221	460	8-10 weeks
P531E.173.560110	560	110	*210	247	505	8-10 weeks
P531E.173.560160	560	160	*210	247	505	8-10 weeks
P531E.173.560200	560	200	*210	247	505	8-10 weeks
P531E.173.630110	630	110	*210	278	544	8-10 weeks
P531E.173.630160	630	160	*210	278	544	8-10 weeks
P531E.173.630200	630	200	*210	278	544	8-10 weeks

\* Spigot lengths suitable for Mill-Pro supplied PN10 EF couplers but shorter than L2 in BSEN 12201-3 table 3

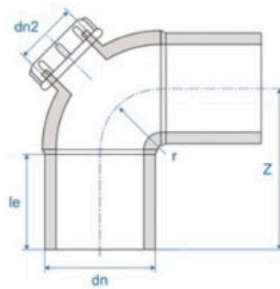

## 45° Moulded Inspection Elbows / LS / Black / PN10 / SDR17

PE100+ long spigot elbows with factory butt fusion welded PE inspection port with screw cap and sealing gasket, mounted on the side of the elbow.

Product Code	dn1	dn2	le	r	z	Availability in Hong Kong
P531E.177.200110	200	110	112	88	147	8-10 weeks
P531E.177.225110	225	110	115	99	134	8-10 weeks
P531E.177.250110	250	110	129	110	162	8-10 weeks
P531E.177.280110	280	110	148	124	200	8-10 weeks
P531E.177.355110	355	110	*160	157	227	8-10 weeks
P531E.177.355160	355	160	*160	157	227	8-10 weeks
P531E.177.400110	400	110	*158	176	215	8-10 weeks
P531E.177.400160	400	160	*158	176	215	8-10 weeks
P531E.177.400200	400	200	*158	176	215	8-10 weeks
P531E.177.450110	450	110	*170	199	249	8-10 weeks
P531E.177.450160	450	160	*170	199	249	8-10 weeks
P531E.177.450200	450	200	*170	199	249	8-10 weeks
P531E.177.500110	500	110	*205	221	272	8-10 weeks
P531E.177.500160	500	160	*205	221	272	8-10 weeks
P531E.177.500200	500	200	*205	221	272	8-10 weeks
P531E.177.560110	560	110	*200	247	279	8-10 weeks
P531E.177.560160	560	160	*200	247	279	8-10 weeks
P531E.177.560200	560	200	*200	247	279	8-10 weeks
P531E.177.630110	630	110	*220	278	317	8-10 weeks
P531E.177.630160	630	160	*220	278	317	8-10 weeks
P531E.177.630200	630	200	*220	278	317	8-10 weeks

\*Spigot lengths suitable for Mill-Pro supplied PN10 EF couplers but shorter than L2 in BSEN 12201-3 table 3

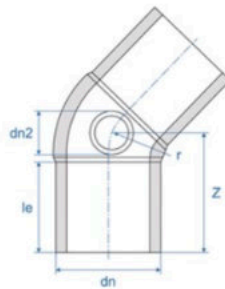



## 90° Moulded Inspection Elbows / LS / Black / PN10 / SDR17

90° PE100+ long spigot elbows with factory butt fusion welded PE inspection port with screw cap and sealing gasket, mounted on the side of the elbow.

Product Code	dn	dn2	le	r	z	Availability in Hong Kong
P531E.178.200110	200	110	125	88	239	8-10 weeks
P531E.178.225110	225	110	135	99	255	8-10 weeks
P531E.178.250110	250	110	130	110	265	8-10 weeks
P531E.178.280110	280	110	*135	124	282	8-10 weeks
P531E.178.355110	355	110	*155	157	365	8-10 weeks
P531E.178.355160	355	160	*155	157	365	8-10 weeks
P531E.178.450110	400	110	*145	176	378	8-10 weeks
P531E.178.450160	400	160	*145	176	378	8-10 weeks
P531E.178.450200	400	200	*145	176	378	8-10 weeks
P531E.178.500110	500	110	*210	221	460	8-10 weeks
P531E.178.500160	500	160	*210	221	460	8-10 weeks
P531E.178.500200	500	200	*210	221	460	8-10 weeks
P531E.178.560110	560	110	*210	247	505	8-10 weeks
P531E.178.560160	560	160	*210	247	505	8-10 weeks
P531E.178.560200	560	200	*210	247	505	8-10 weeks
P531E.178.630110	630	110	*210	278	544	8-10 weeks
P531E.178.630160	630	160	*210	278	544	8-10 weeks
P531E.178.630200	630	200	*210	278	544	8-10 weeks

\*Spigot lengths suitable for Mill-Pro supplied PN10 EF couplers but shorter than L2 in BSEN 12201-3 table 3

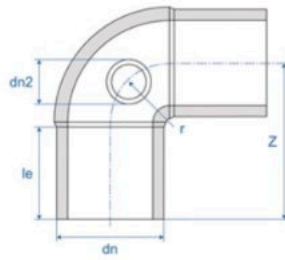

## Black 45° Injection Moulded Spigot Elbows / PN10 / SDR17

Mill-Pro supplies a small range of PE100+ Black Injection moulded spigot elbows. It should be noted in the table below fitting dimension 'le' marked with \* **do not meet the required minimum spigot length** for use as long spigot fittings, given in BS EN 12201-3 Table 3, 'Tubular length'. These fittings DO meet the standard for use as a butt weld fittings and they meet all other requirements given in the standard.

All fittings given in the table below have **sufficient spigot length required for fusion using Friatec electrofusion couplers**. However, certification cannot currently be provided for the fittings compliance to BS EN 12201-3 when used as a long spigot elbow for electrofusion joining.

Product Code	dn	le	r	z	Availability in Hong Kong
P5314.119.110	110	82	55	118	4-6 weeks
P5314.119.160	160	98	80	142	4-6 weeks
P5314.119.200	200	112	100	162	4-6 weeks
P5314.119.225	225	115	113	155	4-6 weeks
P5314.119.250	250	129	125	190	4-6 weeks
P5314.119.280	280	148	140	230	4-6 weeks
P5314.119.355	355	164	178	270	4-6 weeks
P5314.119.400	400	*150	200	255	4-6 weeks
P5314.119.450	450	*170	225	290	4-6 weeks
P5314.119.500	500	*205	250	320	4-6 weeks
P5314.119.560	560	*200	280	345	4-6 weeks
P5314.119.630	630	*220	315	370	4-6 weeks

Fittings where 'le' is marked with an \* do not meet the minimum requirement for minimum tubular length in BS EN 12201-3 Table 3 when being joined with electrofusion couplers.

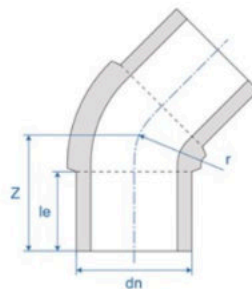

## Black 90° Injection Moulded Spigot Elbows / PN10 / SDR17

Mill-Pro supplies a small range of PE100+ Black Injection moulded spigot elbows. It should be noted in the table below fitting dimension 'le' marked with \* **do not meet the required minimum spigot length** for use as long spigot fittings, given in BS EN 12201-3 Table 3, 'Tubular length'. These fittings DO meet the standard for use as a butt weld fittings and they meet all other requirements given in the standard.

All fittings given in the table below have **sufficient spigot length required for fusion using Friatec electrofusion couplers**. However, certification cannot currently be provided for the fittings compliance to BS EN 12201-3 when used as a long spigot elbow for electrofusion joining.

Product Code	dn	le	r	z	Availability in Hong Kong
P5314.115.110	110	82	55	143	4-6 weeks
P5314.115.160	160	*98	80	177	4-6 weeks
P5314.115.200	200	125	100	239	4-6 weeks
P5314.115.225	225	140	113	255	4-6 weeks
P5314.115.250	250	130	125	265	4-6 weeks
P5314.115.280	280	*135	140	282	4-6 weeks
P5314.115.355	355	*155	178	365	4-6 weeks
P5314.115.450	450	*180	225	410	4-6 weeks
P5314.115.500	500	*210	250	460	4-6 weeks
P5314.115.560	560	*210	280	505	4-6 weeks
P5314.115.630	630	*210	315	544	4-6 weeks

Fittings where 'le' is marked with an \* do not meet the minimum requirement for minimum tubular length in BS EN 12201-3 Table 3 when being joined with electrofusion couplers.

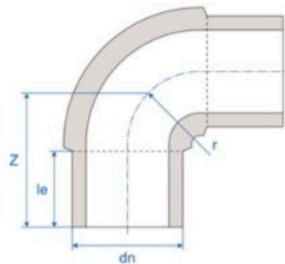



## Backdrop Chamber Bend

Typically referred to as a Backdrop Bends, this single piece assembly is fabricated to order. Backdrop bends are offered in the required DSD drawing fitting radius ( $r = \geq 4 \times DN$ ). The drop pipe material is M90ES SDR 17 CCTV PE 100 RC pipe, there are no joints, steps or internal weld beads in the drop or bend portion, offering an exceptionally smooth internal surface.

Unlike Cast Iron, PE does not corrode so the interior surface of the PE remains smooth over the life of the fitting. Therefore the use of tighter radii bends at the bottom of the drop are possible, with limited risk of blockage. The use of alternatives bend radii may be necessary where a  $r \Rightarrow 4 \times DN$  bend is simply too large to install in the available space.

Mill-Pro PE Backdrop bends are supplied with a factory welded integrated puddle flange in accordance with DSD Appendix 5A, Clause 5.10.3.2.

When PE is cast into concrete there is no adhesion between PE and cement. Due to thermal expansion of the PE during concrete curing, a small gap is created between the PE and the cured concrete after cooling. A Hydrophilic seal is fitted where the PE exits the concrete at the manhole base, this seal expands up to 600% when wet to permanently seal the PE and concrete chamber walls. This seal is designed in accordance with DSD Appendix 5A, Clause 5.10.3.3.

## Fabricated PE100 / RC / Backdrop Manhole Bend / SDR17

### Radius = $\geq 4x DN$

DSD Compliant, dimensions Z1 & Z2 are stated in the tables as greater the or equal to ( $\geq$ ), they can be fabricated longer than the stated value below to suit site requirements, but not less than. It is recommended that dimension Z1 is ordered longer than required and cut to length on site before plastering the entrance.

Product code	DN	dn	Z1	Z2	r	Availability in Hong Kong
P5314.563.160	150	160	$\geq 760$	$\geq 920$	720	8-12 Weeks
P5314.563.225	200	225	$\geq 1068$	$\geq 1243$	1013	8-12 Weeks
P5314.563.250	225	250	$\geq 1185$	$\geq 1365$	1125	8-12 Weeks
P5314.562.280	250	280	$\geq 1190$	$\geq 1381$	1120	8-12 Weeks
P5314.562.355	300	355	$\geq 1510$	$\geq 1735$	1420	8-12 Weeks
P5314.562.400	350/375	400	$\geq 1695$	$\geq 1940$	1600	8-12 Weeks
P5314.562.450	400	450	$\geq 1895$	$\geq 2160$	1800	8-12 Weeks
P5314.562.500	450	500	$\geq 2095$	$\geq 2375$	2000	8-12 Weeks

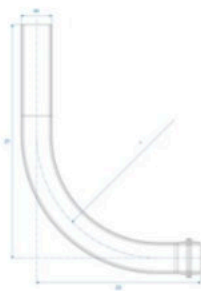

## Fabricated PE100 / RC / Backdrop Manhole Bend / SDR17

### Radius $r = 2.5 \times DN$

Dimensions Z1 & Z2 are stated in the tables as greater the or equal to ( $\geq$ ), they can be fabricated longer than the stated value below to suit site requirements, but not less than. It is recommended that dimension Z1 is ordered longer than required and cut to length on site before plastering the entrance.

Product code	DN	dn	Z1	Z2	r	Availability in Hong Kong
P5314.561.160	150	160	$\geq 440$	$\geq 600$	400	8-12 Weeks
P5314.561.225	200	225	$\geq 618$	$\geq 793$	563	8-12 Weeks
P5314.561.250	225	250	$\geq 685$	$\geq 865$	625	8-12 Weeks
P5314.561.280	250	280	$\geq 770$	$\geq 961$	700	8-12 Weeks
P5314.561.355	300	355	$\geq 978$	$\geq 1203$	888	8-12 Weeks
P5314.561.400	350/375	400	$\geq 1095$	$\geq 1340$	1000	8-12 Weeks
P5314.561.450	400	450	$\geq 1220$	$\geq 1485$	1125	8-12 Weeks
P5314.561.500	450	500	$\geq 1345$	$\geq 1625$	1250	8-12 Weeks
P5314.561.560	500	560	$\geq 1400$	$\geq 1400$	1400	8-12 Weeks
P5314.561.630	525	630	$\geq 1575$	$\geq 1575$	1575	8-12 Weeks

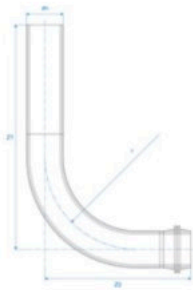

## Fabricated PE100 / RC / Backdrop Manhole Bend / SDR17

### Radius $r = \sim 0.5 \times DN$

Dimensions Z1 & Z2 are stated in the tables as greater the or equal to ( $\geq$ ), they can be fabricated longer than the stated value below to suit site requirements, but not less than. It is recommended that dimension Z1 is ordered longer than required and cut to length on site before plastering the entrance.

Product code	DN	dn	Z1	Z2	r	Availability in Hong Kong
P5314.560.160	150	160	$\geq 116$	$\geq 276$	76	8-12 Weeks
P5314.560.225	200	225	$\geq 162$	$\geq 337$	107	8-12 Weeks
P5314.560.250	225	250	$\geq 179$	$\geq 359$	119	8-12 Weeks
P5314.560.280	250	280	$\geq 203$	$\geq 394$	133	8-12 Weeks
P5314.560.355	300	355	$\geq 259$	$\geq 484$	169	8-12 Weeks
P5314.560.400	350/375	400	$\geq 285$	$\geq 530$	190	8-12 Weeks
P5314.560.450	400	450	$\geq 309$	$\geq 574$	214	8-12 Weeks
P5314.560.500	450	500	$\geq 333$	$\geq 613$	238	8-12 Weeks

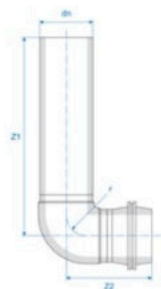

## Drop Tee / Spigot / PE100 / SDR17

Factory tee fabrication with an integrated puddle flange for casting directly into a chamber, with connection by electrofusion to another PE pipe. Manufactured from PE100 components and butt welded in accordance with BS ISO 21307.

Product Code	dn1	dn2	Z1 / Z2	L5	Z3	le	Availability in Hong Kong
P531E.31.160	160	160	≥198	≥257	L5 + 210	150	8-12 Weeks
P531E.31.200	200	200	≥224	≥285	L5 + 210	150	8-12 Weeks
P531E.31.225	225	225	≥251	≥307	L5 + 210	150	8-12 Weeks
P531E.31.250	250	250	≥268	≥345	L5 + 310	250	8-12 Weeks
P531E.31.280	280	280	≥301	≥365	L5 + 310	250	8-12 Weeks
P531E.31.355	355	355	≥361	≥418	L5 + 367	300	8-12 Weeks
P531E.31.400	400	400	≥364	≥435	L5 + 375	300	8-12 Weeks
P531E.31.450	450	450	≥445	≥525	L5 + 385	300	8-12 Weeks
P531E.31.500	500	500	≥518	≥593	L5 + 392	300	8-12 Weeks
P531E.31.560	560	560	≥543	≥650	L5 + 405	300	8-12 Weeks
P531E.31.630	630	630	≥588	≥718	L5 + 417	300	8-12 Weeks

Dimensions Z1, Z2, & L5 can be equal to, or greater than the value given above to allow customisation

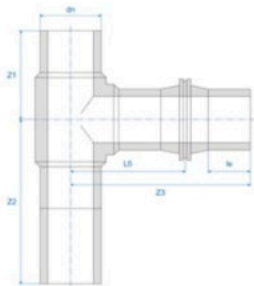



## Drop Tee / Socket / PE100 / SDR17

Factory tee fabrication with an integrated puddle flange for casting directly into a chamber, with connection by rubber ring joint socket to a different pipe material. Manufactured from PE100 components and butt welded in accordance with BS ISO 21307. EPDM seals and socket design according to BS EN 12666-1.

Available for connection to various materials as indicated:

CI (Cast Iron), DI (Ductile Iron), VC (Virtuous Clay), PVC (Plastic pipe)

Product Code	dn1	dn2	Z1 / Z2	L5	Z3	X6	Availability in Hong Kong
P531E.35.160160	160	150 CI EN877	≥198	≥257	L5 + 122	60	8-12 Weeks
P531E.33.160170	160	150 DI EN598	≥198	≥257	L5 + 147	60	8-12 Weeks
P531E.36.160186	160	150 VC	≥198	≥257	L5 + 109	60	8-12 Weeks
P531E.38.160160	160	150 PVC	≥198	≥257	L5 + 99	60	8-12 Weeks
P531E.32.160170	160	150 DI EN598	≥198	≥257	L5 + 104	60	8-12 Weeks
P531E.38.225200	225	200 PVC	≥251	≥307	L5 + 105	70	8-12 Weeks
P531E.34.225210	225	200 CI EN877	≥251	≥307	L5 + 110	70	8-12 Weeks
P531E.33.225222	225	200 DI EN598	≥251	≥307	L5 + 145	70	8-12 Weeks
P531E.36.225239	225	200 VC	≥251	≥307	L5 + 128	70	8-12 Weeks
P531E.32.250222	250	200 DI EN598	≥268	≥345	L5 + 96	80	8-12 Weeks
P531E.34.250247	250	225 CI	≥268	≥345	L5 + 109	80	8-12 Weeks
P531E.36.250268	250	225 VC	≥268	≥345	L5 + 122	80	8-12 Weeks
P531E.38.280250	280	250 PVC	≥301	≥365	L5 + 107	80	8-12 Weeks
P531E.34.280266	280	250 CI	≥301	≥365	L5 + 115	80	8-12 Weeks
P531E.33.280274	280	250 DI EN598	≥301	≥365	L5 + 159	80	8-12 Weeks
P531E.35.280274	280	250 CI EN877	≥301	≥365	L5 + 162	80	8-12 Weeks
P531E.36.280298	280	250 VC	≥301	≥365	L5 + 134	80	8-12 Weeks
P531E.38.355315	355	300 PVC	≥361	≥418	L5 + 144	90	8-12 Weeks
P531E.36.355352	355	300 VC	≥361	≥418	L5 + 166	90	8-12 Weeks
P531E.38.400355	400	350 PVC	≥364	≥435	L5 + 150	90	8-12 Weeks
P531E.34.400370	400	350 CI	≥364	≥435	L5 + 157	90	8-12 Weeks
P531E.32.400378	400	350 DI EN598	≥364	≥435	L5 + 161	90	8-12 Weeks
P531E.35.400403	400	375 CI	≥364	≥435	L5 + 229	90	8-12 Weeks
P531E.33.400403	400	375 DI	≥364	≥435	L5 + 209	90	8-12 Weeks
P531E.36.400445	400	375 VC	≥364	≥435	L5 + 199	90	8-12 Weeks
P531E.34.450424	450	400 CI	≥445	≥525	L5 + 168	90	8-12 Weeks
P531E.32.450429	450	400 DI EN598	≥445	≥525	L5 + 170	90	8-12 Weeks
P531E.35.450429	450	400 CI EN877	≥445	≥525	L5 + 200	90	8-12 Weeks
P531E.39.450450	450	400 PVC	≥445	≥525	L5 + 222	90	8-12 Weeks
P531E.33.450480	450	450 DI EN598	≥445	≥525	L5 + 282	90	8-12 Weeks
P531E.38.500450	500	375 PVC	≥518	≥593	L5 + 163	90	8-12 Weeks
P531E.33.500480	500	450 DI EN598	≥518	≥593	L5 + 208	90	8-12 Weeks
P531E.36.500528	500	450 VC	≥518	≥593	L5 + 206	90	8-12 Weeks
P531E.38.560500	560	450 PVC	≥543	≥650	L5 + 176	90	8-12 Weeks
P531E.32.560532	560	500 DI EN598	≥543	≥650	L5 + 212	90	8-12 Weeks
P531E.35.560532	560	500 CI EN877	≥543	≥650	L5 + 227	90	8-12 Weeks
P531E.35.630635	630	600 CI EN877	≥588	≥718	L5 + 333	90	8-12 Weeks
P531E.33.630635	630	600 DI EN598	≥588	≥718	L5 + 357	90	8-12 Weeks

Dimensions Z1, Z2, & L5 can be equal to, or greater than the value given above to allow customisation

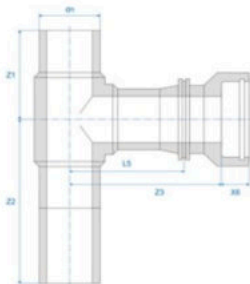



## Bends (horizontal)

The use of curved sewers is common practice in many countries to reduce the requirement for Manholes when a change in direction is required. Experience has demonstrated that blockages in gravity PE pipelines lines are extremely uncommon. Guidance about the radius of curvature, types and quantity of bends used between manholes were developed by various Authorities, their use of bends has reduced the number of manholes in non entry sewers and stormwater lines by up to 75%! This reduction provides authorities enormous cost reduction in both installation and ongoing maintenance costs.

Specifications for curved PE sewers generally follow the theory

1. *The bend radius increases as the bend angle increases*
2. *Limits on the number of bends installed between manholes.*

For Hong Kong, the DSD Appendix 5A Table 5A-7 states:

Angle	Radius	Number of segments in fabricated bends >500 DN/OD
≤ 22°	$r \geq 4 \times \text{pipe DN/OD}$	≥ 3
> 22° but ≤ 45°	$r \geq 7 \times \text{pipe DN/OD}$	≥ 4
>45°	$r \geq 10 \times \text{pipe DN/OD}$	≥ 6

### Swept bends

Bends installed horizontally in a gravity line, sizes up to DN/OD 500 should be swept type as they do not have internal welds or flat angular surfaces and offer a completely smooth bore as described in BS EN 12201-3 Annex B.4.

### Segmented bends

In larger sizes, these bends are factory-fabricated using the segment design method, as described in BS EN 12201-3 Annex B.3.

*Product specifications and dimensions are subject to change without notice.*

*For the latest information refer to our website: [www.millpro.com.hk](http://www.millpro.com.hk) or contact our [sales team](#).*



*This mark is used to identify Mill-Pro products that meet the requirements of the Drainage Supplies Department PS Appendix 22.09. The use of this mark is not endorsed by the DSD and is not intended to infer approval by the DSD.*

## 11° Swept Bends LS / PE100RC / M90ES / SDR17 / SN24

Brown stripe	Green stripe	dn	le	$r = 4.5 \times dn$	$z - 11^\circ$	Availability in Hong Kong
P5M5E.360.110	P5MGE.360.110	110	150	495	198	6-8 weeks
P5M5E.360.160	P5MGE.360.160	160	150	720	219	6-8 weeks
P5M5E.360.225	P5MGE.360.225	225	150	1013	247	6-8 weeks
P5M5E.360.250	P5MGE.360.250	250	250	1125	358	6-8 weeks

Brown stripe	Green stripe	dn	le	$r = 4 \times dn$	$z - 11^\circ$	Availability in Hong Kong
P5M5E.350.280	P5MGE.350.280	280	250	1120	358	6-8 weeks
P5M5E.350.355	P5MGE.350.355	355	300	1420	437	6-8 weeks
P5M5E.350.400	P5MGE.350.400	400	300	1600	454	6-8 weeks
P5M5E.350.450	P5MGE.350.450	450	300	1800	473	6-8 weeks
P5M5E.350.500	P5MGE.350.500	500	350	2000	543	6-8 weeks

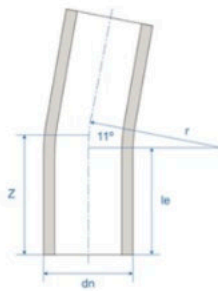

## Single Mitre Custom Segmented Spigot Bends / SN3-381 / SDR33-7.4

Single mitre segmented bends are manufactured from pipes supplied for the contract, such as M90SE or M100E, in any angle from 1° to 15° with radii  $\geq 4 \times OD$ . Bend sizes are only limited by the pipes size and rating. Contact us for specific requirements.

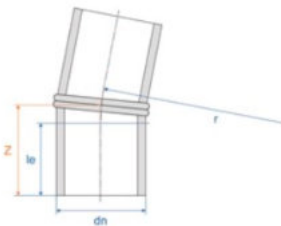



## 11° Segmented Spigot CCTV Bends / SN24 / SDR17 / Striped

Manufactured from Mill-Pro M90SE PE100 RC SDR17 CCTV pipe and fabricated according to BS EN 12201-3, clause B.3, using butt weld techniques according to BS ISO 21307. They feature long spigots for electrofusion or butt fusion joining and 1D and 2D bar code stickers for complete product traceability.

**Segmented bends** are manufactured from a pipe, with cut angles  $\leq 7.5^\circ$ . Generally, the internal weld beads are removed where possible and external weld beads are not removed unless ordered otherwise.

Any bend angle from  $0^\circ$  to  $15^\circ$  can be custom manufactured, standard angle for a single mitre bend is  $11^\circ$  with a radius of  $\geq 4 \times OD$ , as given in the table below.

NOTE: The spigot ends must be prepared in accordance with the *general installation instructions* using a spigot *mechanical peeler*, *90% Isopropyl alcohol wipes*.

Brown stripe	Green stripe	dn	le	r = 4.0 dn	z - 11° Single mitre	Availability in Hong Kong
P5M5E.240.560	P5MGE.240.560	560	350	2240	566	6-8 weeks
P5M5E.240.630	P5MGE.240.630	630	350	2520	593	6-8 weeks
P5M5E.240.710	P5MGE.240.710	710	350	2840	623	6-8 weeks
P5M5E.240.800	P5MGE.240.800	800	350	3200	658	6-8 weeks
P5M5E.240.900	P5MGE.240.900	900	400	3600	747	6-8 weeks
P5M5E.240.1000	P5MGE.240.1000	1000	400	4000	785	6-8 weeks
P5M5E.240.1200	P5MGE.240.1200	1200	400	4800	862	6-8 weeks
P5M5E.240.1400	P5MGE.240.1400	1400	550	5600	1089	6-8 weeks
P5M5E.240.1600	P5MGE.240.1600	1600	550	6400	1166	6-8 weeks

Larger sizes to dn2000 in SN ratings from SN3 to SN381 are available in M100E pipe, subject to pipe availability.

Bends with brown or green stripes can only be supplied when also supplying the matching pipe.

To transport large bore bends, these may need to be made in sections and joined on site.

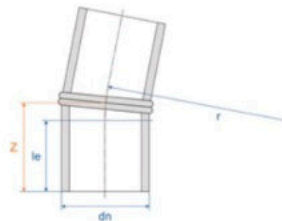

## 22° Swept Bends LS / PE100RC / M90ES / SDR17 / SN24

Brown Stripe	Green Stripe	dn	le	r = 4.5 x dn	z - 22°	Availability in Hong Kong
P5M5E.361.110	P5MGE.361.110	110	150	495	350	6-8 weeks
P5M5E.361.160	P5MGE.361.160	160	150	720	441	6-8 weeks
P5M5E.361.225	P5MGE.361.225	225	150	1013	559	6-8 weeks
P5M5E.361.250	P5MGE.361.250	250	250	1125	705	6-8 weeks

Brown stripe	Green stripe	dn	le	r = 4 x dn	z - 22°	Availability in Hong Kong
P5M5E.351.280	P5MGE.351.280	280	250	1120	468	6-8 weeks
P5M5E.351.355	P5MGE.351.355	355	300	1420	576	6-8 weeks
P5M5E.351.400	P5MGE.351.400	400	300	1600	611	6-8 weeks
P5M5E.351.450	P5MGE.351.450	450	300	1800	650	6-8 weeks
P5M5E.351.500	P5MGE.351.500	500	350	2000	739	6-8 weeks

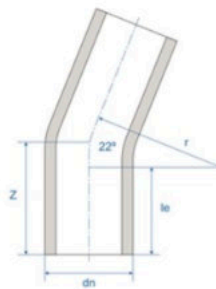

## Two Mitre Custom Segment Spigot Bends / SN3-381 / SDR33-7.4

As above, single mitre segmented bends are manufactured from pipes supplied for the contract, such as M90SE or M100E, in any angle from 16° to 30° with radii  $\geq 4 \times OD$ . Bend sizes are only limited by the pipes size and rating. Contact us for specific bend requirements.

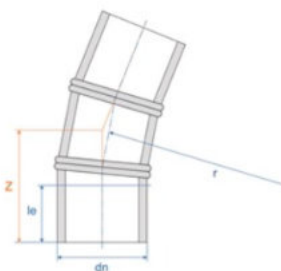

## 22° Segmented Spigot CCTV Bends / SN24 / SDR17 / Striped

Manufactured from Mill-Pro M90SE PE100 RC SDR17 CCTV pipe and fabricated according to BS EN 12201-3, clause B.3, using butt weld techniques according to BS ISO 21307. They feature long spigots for electrofusion or butt fusion joining and 1D and 2D bar code stickers for complete product traceability.

**Segmented bends** are manufactured from a pipe, with cut angles  $\leq 7.5^\circ$ . Generally, the internal weld beads are removed where possible and external weld beads are not removed unless ordered otherwise.

Any bend angle from  $16^\circ$  to  $30^\circ$  can be custom manufactured, standard angle for a two mitre bend is  $22^\circ$  with a radius of  $\geq 4 \times OD$ , as given in the table below.

Brown stripe	Green stripe	dn	le	r = 4.0 dn	z - 22° Two mitre	Availability in Hong Kong
P5M5E.241.560	P5MGE.241.560	560	350	2240	785	6-8 weeks
P5M5E.241.630	P5MGE.241.630	630	350	2520	840	6-8 weeks
P5M5E.241.710	P5MGE.241.710	710	350	2840	902	6-8 weeks
P5M5E.241.800	P5MGE.241.800	800	350	3200	972	6-8 weeks
P5M5E.241.900	P5MGE.241.900	900	400	3600	1100	6-8 weeks
P5M5E.241.1000	P5MGE.241.1000	1000	400	4000	1178	6-8 weeks
P5M5E.241.1200	P5MGE.241.1200	1200	400	4800	1333	6-8 weeks
P5M5E.241.1400	P5MGE.241.1400	1400	550	5600	1639	6-8 weeks
P5M5E.241.1600	P5MGE.241.1600	1600	550	6400	1794	6-8 weeks

Larger sizes to dn2000 in PN ratings from PN4 to PN10 are available in M100E pipe, subject to pipe availability.  
 Bends with brown or green twin stripes can only be supplied when also supplying the matching pipe.  
 To transport large bore bends, these may need to be made in sections and joined on site.

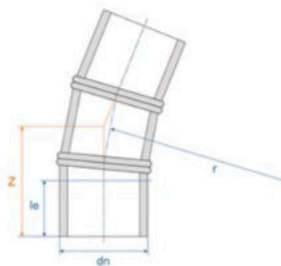

## 30° Swept Bends LS / PE100RC / M90ES / SDR17 / SN24

Brown stripe	Green stripe	dn	le	r = 7 x dn	z -30°	Availability in Hong Kong
P5M5E.382.225	P5MGE.382.225	225	150	1575	572	6-8 weeks
P5M5E.382.250	P5MGE.382.250	250	250	1750	719	6-8 weeks
P5M5E.382.280	P5MGE.382.280	280	250	1960	775	6-8 weeks
P5M5E.382.355	P5MGE.382.355	355	300	2485	966	6-8 weeks
P5M5E.382.400	P5MGE.382.400	400	300	2800	1050	6-8 weeks

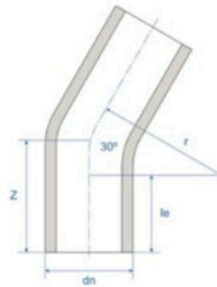

## Two Mitre Custom Segmented Spigot Bends / SN3-381 / SDR33-7.4

As above, single mitre segmented bends are manufactured from pipes supplied for the contract, such as M90SE or M100E, in any angle from 16° to 30° with radii from 1.5 - 2.5xOD. Bend sizes are only limited by the pipes size and rating. Contact us for specific bend requirements.

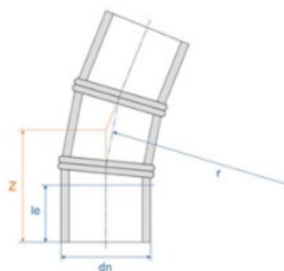



## 30° Segmented Spigot CCTV Bends / SN24 / SDR17 / Striped

Manufactured from Mill-Pro M90SE PE100 RC SDR17 CCTV pipe and fabricated according to BS EN 12201-3, clause B.3, using butt weld techniques according to BS ISO 21307. They feature long spigots for electrofusion or butt fusion joining and 1D and 2D bar code stickers for complete product traceability.

**Segmented bends** are manufactured from a pipe, with cut angles  $\leq 7.5^\circ$ . Generally, the internal weld beads are removed where possible and external weld beads are not removed unless ordered otherwise.

Any bend angle from  $16^\circ$  to  $30^\circ$  can be custom manufactured, standard angle for a single mitre bend is  $30^\circ$  with a radius of  $\geq 4 \times OD$ , as given in the table below.

Brown stripe	Green stripe	dn	le	r = 7.0 dn	z - 30° Two mitre	Availability in Hong Kong
P5M5E.247.560	P5MGE.247.560	560	350	3920	1400	6-8 weeks
P5M5E.247.630	P5MGE.247.630	630	350	4410	1532	6-8 weeks
P5M5E.247.710	P5MGE.247.710	710	350	4970	1682	6-8 weeks
P5M5E.247.800	P5MGE.247.800	800	350	5600	1851	6-8 weeks
P5M5E.247.900	P5MGE.247.900	900	400	6300	2088	6-8 weeks
P5M5E.247.1000	P5MGE.247.1000	1000	400	7000	2276	6-8 weeks
P5M5E.247.1200	P5MGE.247.1200	1200	400	8400	2651	6-8 weeks
P5M5E.247.1400	P5MGE.247.1400	1400	550	9800	3176	6-8 weeks
P5M5E.247.1600	P5MGE.247.1600	1600	550	11200	3551	6-8 weeks

Larger sizes to dn2000 in PN ratings from PN4 to PN10 are available in M100E pipe, subject to pipe availability.  
 Bends with brown or green twin stripes can only be supplied when also supplying the matching pipe.  
 To transport large bore bends, these may need to be made in sections and joined on site.

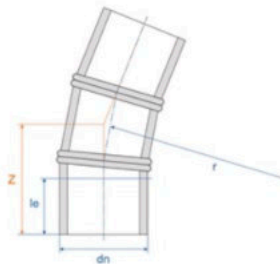

## 45° Swept Bends LS / PE100RC / M90ES / SDR17 / SN24

Brown stripe	Green stripe	dn	le	r = 7 x dn	z - 45°	Availability in Hong Kong
P5M5E.383.225	P5MGE.383.225	225	150	1575	802	6-8 weeks
P5M5E.383.250	P5MGE.383.250	250	250	1750	975	6-8 weeks
P5M5E.383.280	P5MGE.383.280	280	250	1960	1062	6-8 weeks
P5M5E.383.355	P5MGE.383.355	355	300	2485	1329	6-8 weeks
P5M5E.383.400	P5MGE.383.400	400	300	2800	1460	6-8 weeks

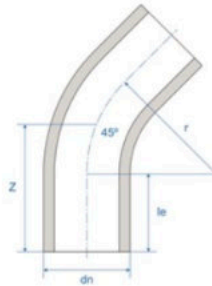

## Three Mitre Custom Segment Spigot Bends / PN4-25 / SDR41-7.4

As above, three mitre segmented bends are manufactured from pipes supplied for the contract, such as M90SE or M100E, in any angle from 31° to 45° with radii from 1.5 - 2.5xOD. Bend sizes are only limited by the pipes size and rating. Contact us for specific requirements.

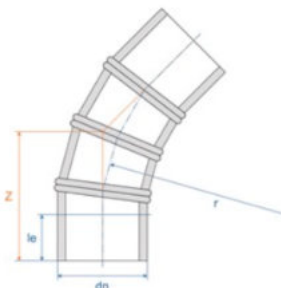

## 45° Segmented Spigot CCTV Bends / SN24 / SDR17 / Striped

Manufactured from Mill-Pro M90SE PE100 RC SDR17 CCTV pipe and fabricated according to BS EN 12201-3, clause B.3, using butt weld techniques according to BS ISO 21307. They feature long spigots for electrofusion or butt fusion joining and 1D and 2D bar code stickers for complete product traceability.

**Segmented bends** are manufactured from a pipe, with cut angles  $\leq 7.5^\circ$  and therefore are not subject to pressure de-rating factor required in BS EN 12201 Clause B.3. Generally, the internal weld beads are removed where possible and external weld beads are not removed unless ordered otherwise.

Any bend angle from  $31^\circ$  to  $45^\circ$  can be custom manufactured, standard angle for a three mitre bend is  $45^\circ$  with a radius of  $2.5 \times OD$ , as given in the table below.

NOTE: The spigot ends must be prepared in accordance with the *general installation instructions* using a spigot *mechanical peeler*, *90% Isopropyl alcohol wipes*.

Brown stripe	Green stripe	dn	le	r = 7.0 dn	z - 45° Three mitre	Availability in Hong Kong
P5M5E.248.560	P5MGE.248.560	560	350	3920	1974	6-8 weeks
P5M5E.248.630	P5MGE.248.630	630	350	4410	2177	6-8 weeks
P5M5E.248.710	P5MGE.248.710	710	350	4970	2409	6-8 weeks
P5M5E.248.800	P5MGE.248.800	800	350	5600	2670	6-8 weeks
P5M5E.248.900	P5MGE.248.900	900	400	6300	3010	6-8 weeks
P5M5E.248.1000	P5MGE.248.1000	1000	400	7000	3299	6-8 weeks
P5M5E.248.1200	P5MGE.248.1200	1200	400	8400	3879	6-8 weeks
P5M5E.248.1400	P5MGE.248.1400	1400	550	9800	4609	6-8 weeks
P5M5E.248.1600	P5MGE.248.1600	1600	550	11200	5189	6-8 weeks

Larger sizes to dn2000 in PN ratings from PN4 to PN10 are available in M100E pipe, subject to pipe availability.  
 Bends with brown or green twin stripes can only be supplied when also supplying the matching pipe.  
 To transport large bore bends, these may need to be made in sections and joined on site.

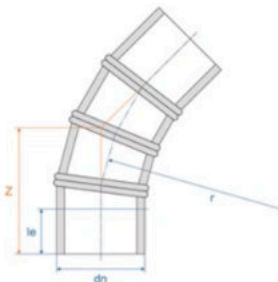

## Chamber Tees

A form of curved sewer that is less than the minimum radius requirements for horizontal bends. Because the radius of curvature is less than that required in PS Appendix 5A Clause 5.8.4, they are designed with a size on size inspection opening to allow non-man access for cleaning or inspection.

These are used where site space prevents the installation of a concrete manhole chamber, but a change in direction is required, therefore include inspection / access capability.

Fabricated from a fitting tee body with segmented angles to provide the change in direction.

### Chamber Tees / LS / SDR17

One mitre 1° to 15°	Three mitre 16° to 45°	Five mitre 46° to 75°	Chamber cap	Pipe dimensions			Minimum dimensions					Availability in Hong Kong
				DN	OD	SDR	ROC	le LS	H	B	D2	
P531E.T1.160	P531E.T3.160	P531E.T5.160	P531E.T0.160	150	160	17	≥ 368	150	≥ 255	50	147	4-6 Weeks
P531E.T1.225	P531E.T3.225	P531E.T5.225	P531E.T0.225	200	225	17	≥ 518	150	≥ 288	50	206	4-6 Weeks
P531E.T1.250	P531E.T3.250	P531E.T5.250	P531E.T0.250	225	250	17	≥ 575	250	≥ 400	50	229	4-6 Weeks
P531E.T1.280	P531E.T3.280	P531E.T5.280	P531E.T0.280	250	280	17	≥ 644	250	≥ 415	50	256	4-6 Weeks
P531E.T1.355	P531E.T3.355	P531E.T5.355	P531E.T0.355	300	355	17	≥ 817	300	≥ 503	50	325	4-6 Weeks
P531E.T1.400	P531E.T3.400	P531E.T5.400	P531E.T0.400	375	400	17	≥ 920	300	≥ 525	50	366	4-6 Weeks
P531E.T1.450	P531E.T3.450	P531E.T5.450	P531E.T0.450	400	450	17	≥ 1035	300	≥ 550	50	412	4-6 Weeks
P531E.T1.500	P531E.T3.500	P531E.T5.500	P531E.T0.500	450	500	17	≥ 1150	350	≥ 625	50	457	4-6 Weeks
P531E.T1.560	P531E.T3.560	P531E.T5.560	P531E.T0.560	500	560	17	≥ 1288	350	≥ 655	50	512	4-6 Weeks
P531E.T1.630	P531E.T3.630	P531E.T5.630	P531E.T0.630	525	630	17	≥ 1449	350	≥ 690	50	576	4-6 Weeks
P531E.T1.710	P531E.T3.710	P531E.T5.710	P531E.T0.710	600	710	17	≥ 1633	350	≥ 730	50	649	4-6 Weeks
P531E.T1.800	P531E.T3.800	P531E.T5.800	P531E.T0.800	675	800	17	≥ 1840	350	≥ 775	50	732	4-6 Weeks

≥ Indicates the dimension can be as given, or greater, but not less than the value stated in the table above.

Other SDR and larger size dimensions available on request, All dimensions in mm

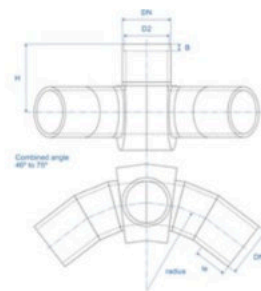
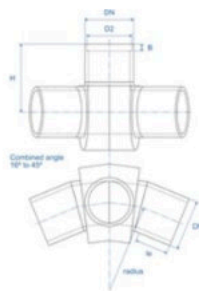
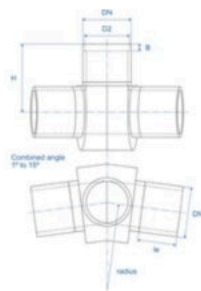





## Intakes

Mill-Pro offers a wide range of injection moulded and fabricated tee pieces including:

- *Injection Moulded Electrofusion Tees*
- *Injection Moulded Spigot Tees*
- *Electrofusion Saddles*
- *Fabricated Tees.*

**Injection moulded Electrofusion Tees** are used for smaller diameter pipelines ( $\leq 315$  OD). Moulded in a single shot and in both equal and reducing offtakes. They do not contain angled butt welds and do not require de-ration.

**Injection moulded Spigot Tees** are moulded in a single shot and are available in sizes up to dn 630 in equal and reducing offtakes. They do not contain angled butt welds and do not require de-ration.

**Electrofusion saddles** are ideal for smaller diameter takeoffs in larger size mains where cutting in a Tee causes significant disruption and cost. Saddles can be used to conduct live cut-ins to existing pipelines and install air valves in locations where clearance above the pipe crown is limited.

**Fabricated Tees** in sizes from dn355 are manufactured by CNC machining a 'Fitting Body' from extruded hollow PE bar then pipe spigots are factory butt-welded on. The required tee reinforcement is incorporated directly into the fitting body during machining, therefore they do not require de-ration. Any custom tee design can be made in any size, including reducing, scour and angled off takes. Fabricated tees are ideal for use in valve and pump chambers, where unique one-off components can be manufactured, eliminating Ductile Iron fittings to reduce long term maintenance.

**Note:** *The specifications for fabrication and type testing for the supply of fabricated fittings to ensure their performance, are given in the Hong Kong Drainage Services Department, Appendix 5A, Clause 5.5.7.*

*Product specifications and dimensions are subject to change without notice.*

*For the latest information refer to our website: [www.millpro.com.hk](http://www.millpro.com.hk) or contact our [sales team](#).*

## Black Spigot Saddle / SA XL / PN16 / SDR11

The Friatec SA XL electrofusion spigot saddles are used for making large diameter offtakes (up to dn355) on large diameter PE mains up to dn1200. In sewer rising mains these fitting would be used to install additional CCTV inspection points, or an inverted offtake for a drain scour, after the line is commissioned.

The SA XL can be installed during construction or post-construction when the pipeline is under normal operating pressure. Connections can be made 'live' using under pressure tapping equipment. This prevents the main having to be shut down during the installation process.

Pressure testing of the saddle after fusion is recommended, before drilling the tapping hole into the main pipe.

Assembly is conducted using a FRIATOOLS *vacuum pump* and the corresponding FRIATOOLS *plunger*. The vacuum unit sucks the saddle down onto the surface of the pipe providing the necessary force to achieve optimal electrofusion to the pipe surface. Tapping in the unpressurised condition can be achieved using the correct size hole saw.

Product Code	dn1	dn2	da	h	L1	L2	le	Z1	Availability in Hong Kong
P3316.187.400225	400	225	172	263	530	403	210	483	8-12 weeks
P3316.187.400250	400	250	187	261	530	417	210	483	8-12 weeks
P3316.187.450225	450	225	172	267	530	421	210	530	8-12 weeks
P3316.187.450250	450	250	187	272	530	426	210	530	8-12 weeks
P3316.187.500225	500	225	172	265	530	388	210	521	8-12 weeks
P3316.187.500250	500	250	187	263	530	380	210	521	8-12 weeks
P3316.187.500280	500	280	225	265	590	388	210	521	8-12 weeks
P3316.187.500315	500	315	254	268	590	446	210	573	8-12 weeks
P3316.187.560225	560	225	172	263	530	402	210	577	8-12 weeks
P3316.187.560250	560	250	187	263	530	398	210	577	8-12 weeks
P3316.187.560280	560	280	225	265	590	404	210	577	8-12 weeks
P3316.187.560315	560	315	254	268	590	402	210	564	8-12 weeks
P3316.187.560355	560	355	286	260	630	451	210	618	8-12 weeks
P3316.187.560400	560	400	322	260	630	451	210	618	8-12 weeks
P3316.187.630225	630	225	172	265	530	422	210	634	8-12 weeks
P3316.187.630250	630	250	187	267	530	419	210	634	8-12 weeks
P3316.187.630280	630	280	225	263	590	420	210	634	8-12 weeks
P3316.187.630315	630	315	254	265	590	417	210	621	8-12 weeks
P3316.187.630355	630	355	286	269	630	422	220	616	8-12 weeks
P3316.187.630400	630	400	322	267	630	419	220	616	8-12 weeks
P3316.187.710225	710	225	172	270	530	447	210	712	8-12 weeks
P3316.187.710250	710	250	187	265	530	437	210	712	8-12 weeks
P3316.187.710280	710	280	225	268	590	445	210	712	8-12 weeks
P3316.187.710315	710	315	254	268	590	439	210	694	8-12 weeks
P3316.187.710355	710	355	286	285	630	457	220	694	8-12 weeks
P3316.187.710400	710	400	322	275	630	447	220	694	8-12 weeks
P3316.187.800225	800	225	172	270	530	381	210	643	8-12 weeks
P3316.187.800250	800	250	187	275	530	384	210	643	8-12 weeks
P3316.187.800280	800	280	225	268	590	382	210	643	8-12 weeks
P3316.187.800315	800	315	254	268	590	377	210	629	8-12 weeks
P3316.187.800355	800	355	286	290	630	483	220	772	8-12 weeks
P3316.187.800400	800	400	322	275	630	468	220	772	8-12 weeks
P3316.187.900225	900	225	172	268	530	396	210	714	8-12 weeks
P3316.187.900250	900	250	187	278	530	402	210	714	8-12 weeks
P3316.187.900280	900	280	225	268	590	396	210	714	8-12 weeks
P3316.187.900315	900	315	254	269	590	393	210	700	8-12 weeks
P3316.187.900355	900	355	286	305	630	429	220	700	8-12 weeks
P3316.187.900400	900	400	322	275	630	399	220	700	8-12 weeks
P3316.187.1000160	1000	160	123	300	530	390	249	654	8-12 weeks
P3316.187.1000225	1000	225	172	270	530	396	210	653	8-12 weeks
P3316.187.1000250	1000	250	187	280	530	366	210	653	8-12 weeks
P3316.187.1000280	1000	280	225	270	590	361	210	653	8-12 weeks
P3316.187.1000315	1000	315	254	270	590	358	210	642	8-12 weeks
P3316.187.900355	900	355	286	305	630	429	220	700	8-12 weeks
P3316.187.900400	900	400	322	275	630	399	220	700	8-12 weeks
P3316.187.1000160	1000	160	123	300	530	390	249	654	8-12 weeks
P3316.187.1000225	1000	225	172	270	530	396	210	653	8-12 weeks

Continued on next page

## Black Spigot Saddle / SA XL / PN16 / SDR11

Continued...

Product Code	dn1	dn2	da	h	L1	L2	le	Z1	Availability in Hong Kong
P3316.187.1000250	1000	250	187	280	530	366	210	653	8-12 weeks
P3316.187.1000280	1000	280	225	270	590	361	210	653	8-12 weeks
P3316.187.1000315	1000	315	254	270	590	358	210	642	8-12 weeks
P3316.187.1000355	1000	355	286	305	630	444	220	774	8-12 weeks
P3316.187.1000400	1000	400	322	278	630	417	220	774	8-12 weeks
P3316.187.1200160	1200	160	123	300	530	375	250	655	8-12 weeks
P3316.187.1200225	1200	225	172	270	530	346	210	655	8-12 weeks
P3316.187.1200250	1200	250	187	280	530	354	210	655	8-12 weeks
P3316.187.1200280	1200	280	225	270	590	345	210	655	8-12 weeks
P3316.187.1200315	1200	315	254	270	590	343	210	645	8-12 weeks
P3316.187.1200355	1200	355	286	305	630	413	220	759	8-12 weeks
P3316.187.1200400	1200	400	322	278	630	385	220	759	8-12 weeks

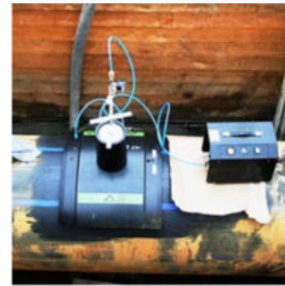
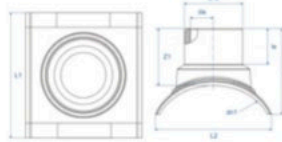

## Black Spigot Saddle / SA XL / PN10 / SDR17

Product Code	dn1	dn2	da	h	L1	L2	le	Z1	Availability in Hong Kong
P3314.187.1000160	1000	160	123	300	530	390	249	654	8-12 weeks
P3314.187.1200160	1200	160	123	300	530	375	250	655	8-12 weeks

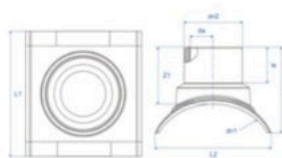

## Black Spigot Saddle / SA UNI / PN16 / SDR11

As above, Friatec SA UNI electrofusion spigot saddles provide for small offtake connections typically for air valves or sampling points (such as pressure transducers) and can be installed during construction or post-construction when the pipeline is under normal operating pressure using under pressure tapping equipment. This prevents the main having to be shut down during the installation process.

**Pressure testing of the saddle after fusion is recommended, before drilling the tapping hole into the main pipe.** This is performed using the integrated pressure nozzle and pressure test adaptor – FWDPA.

Assembly is conducted using the FRIATOOLS clamping unit *UNITOP*. Tapping in the unpressurised condition can be achieved using the correct size hole saw.

Product Code	dn1	dn2	da	L1	L2	le	Z1	Availability in Hong Kong
P3316.187.250-280110	250-280	110	82	260	279	82	140	8-12 weeks
P3316.187.250-280160	250-280	160	123	260	279	98	158	8-12 weeks
P3316.187.315-400110	315-400	110	82	280	279	82	140	8-12 weeks
P3316.187.315-400160	315-400	160	123	280	279	98	158	8-12 weeks
P3316.187.450-800110	450-800	110	82	307	279	82	140	8-12 weeks
P3316.187.450-800160	450-800	160	123	307	279	98	158	8-12 weeks

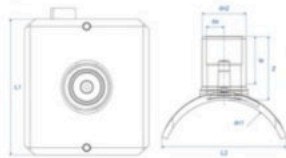
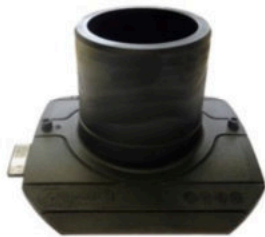

## Black Spigot Saddle / ASA UNI / PN2.5 / SDR17

Product Code	dn1	dn2	da	L1	L2	le	Z1	Availability in Hong Kong
P3310.187.630-900160	630-900	160	123	307	279	98	158	8-12 weeks

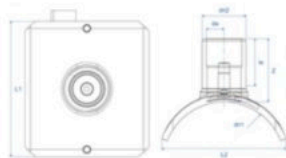



## Black Spigot Saddle / SA / PN16 / SDR11

The Friatec SA electrofusion spigot saddles with bolt-on underpart can be installed during construction or post-construction when the pipeline is under normal operating pressure. Connections can be made 'live' using under pressure tapping equipment. This prevents the main having to be shut down during the installation process.

**Pressure testing of the saddle after fusion is recommended, before drilling the tapping hole into the main pipe.**

Friatec spigot offtake saddle Installation can be either during construction or post-construction when the pipeline is under normal operating pressure. This prevents the main having to be shut down during the installation process.

Product Code	dn1	dn2	L1	L2	le	Z1	Availability in Hong Kong
P3316.083.160110	160	110	265	223	82	140	8-12 weeks
P3316.083.225110	225	110	279	284	82	140	8-12 weeks
P3316.083.225160	225	160	279	284	98	157	8-12 weeks

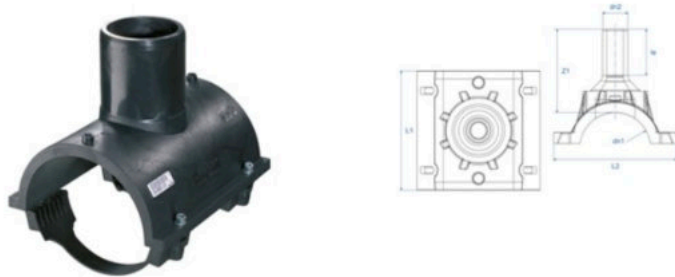

## Sewage Saddle Top Loading / ASA TL / PN2.5

Product Code	dn1	dn2	L2	L1	Availability in Hong Kong
P3310.012.225160	225	160	270	76	8-12 weeks
P3310.012.250160	250	160	270	76	8-12 weeks
P3310.012.280160	280	160	270	76	8-12 weeks
P3310.012.355160	355	160	270	76	8-12 weeks
P3310.012.400160	400	160	270	76	8-12 weeks
P3310.012.450160	450	160	270	76	8-12 weeks
P3310.012.500-560160	500-560	160	270	76	8-12 weeks



## Transition Saddle Top Loading / ASA TL KG / PN0.5

Product Code	dn1	dn2	L2	L1	Availability in Hong Kong
P3310.013.225160	225	160	270	76	8-12 weeks
P3310.013.250160	250	160	270	76	8-12 weeks
P3310.013.280160	280	160	270	76	8-12 weeks
P3310.013.355160	355	160	270	76	8-12 weeks
P3310.013.500-630160	500-630	160	270	76	8-12 weeks



## Sewage Saddle Vacuum Loading / ASA VL / PN2.5 / SDR17

Product Code	dn1	dn2	L1	L2	le	Availability in Hong Kong
P3310.014.355225	355	225	359	425	144	8-12 weeks
P3310.014.450225	450	225	376	425	144	8-12 weeks
P3310.014.560225	560	225	412	425	144	8-12 weeks
P3310.014.630225	630	225	416	425	144	8-12 weeks



## Connecting Spigot to VCP or RC / ASA-Multi / PN0.5 / SDR17

Product Code	dn1	dn2	L1	Z1	Availability in Hong Kong
P531E.017.250160	250	160	146	250	8-12 weeks
P531E.017.250-300160	250-300	160	146	250	8-12 weeks
P531E.017.300-350160	300-350	160	146	250	8-12 weeks



## Black Bellmouth / Long Spigot / PN10 / SDR17

Mill-Pro's fabricated Black PE100+ long spigot Bellmouth fittings are designed for embedment in concrete to replace traditional ductile Iron bellmouth discharge fittings and connect directly by electrofusion to the incoming our outgoing PE pipe. They feature a full tensile strength puddle flange, complete with an integrated waterstop Hydrophilic sealing ring to ensure watertight encasement.

Can be factory fabricated with elbows or other fittings into the required compact design for complete encasement.

Product Code	dn	ID mean	D1	L2	Z1	Availability in Hong Kong
P531E.065.110	110	96	144	150	294	6-8 weeks
P531E.065.160	160	140	210	150	305	6-8 weeks
P531E.065.200	200	175	263	150	314	6-8 weeks
P531E.065.225	225	197	295	150	319	6-8 weeks
P531E.065.250	250	219	328	250	425	6-8 weeks
P531E.065.280	280	245	368	250	432	6-8 weeks
P531E.065.355	355	311	435	300	493	6-8 weeks
P531E.065.400	400	350	490	300	510	6-8 weeks
P531E.065.450	450	394	552	300	531	6-8 weeks
P531E.065.500	500	438	613	300	549	6-8 weeks
P531E.065.560	560	490	687	300	574	6-8 weeks
P531E.065.630	630	552	773	300	601	6-8 weeks
P531E.065.710	710	622	871	300	633	6-8 weeks
P531E.065.800	800	701	981	300	667	6-8 weeks
P531E.065.900	900	788	1104	400	809	6-8 weeks
P531E.065.1000	1000	876	1227	400	847	6-8 weeks

Bellmouth fittings are not designed for horizontal encasement into the base reservoir walls where significant head may be applied to the waterstop hydrophilic seal. In such applications contact us for alternate designs.

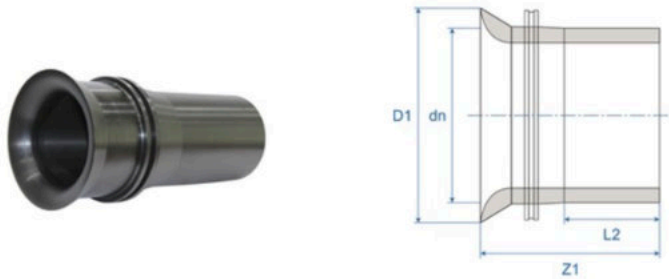

## Black Bellmouth / Butt Fusion / PN10 / SDR17

Mill-Pro's fabricated Black PE100+ butt weld Bellmouth fittings are designed for embedment in concrete to replace traditional ductile Iron bellmouth discharge fittings and connect to other PE components by butt fusion. They feature a full tensile strength puddle flange, complete with an integrated waterstop Hydrophilic sealing ring to ensure watertight encasement.

Typically factory fabricated with elbows or other fittings into the required compact design for complete encasement.

Product Code	dn	IDmean	D1	L2	Z1	Availability in Hong Kong
P231E.065.110	110	96	144	28	172	6-8 weeks
P231E.065.160	160	140	210	40	195	6-8 weeks
P231E.065.200	200	175	263	50	214	6-8 weeks
P231E.065.225	225	197	295	55	224	6-8 weeks
P231E.065.250	250	219	328	60	235	6-8 weeks
P231E.065.280	280	245	368	70	252	6-8 weeks
P231E.065.355	355	311	435	90	283	6-8 weeks
P231E.065.400	400	350	490	95	305	6-8 weeks
P231E.065.450	450	394	552	95	326	6-8 weeks
P231E.065.500	500	438	613	95	344	6-8 weeks
P231E.065.560	560	490	687	95	369	6-8 weeks
P231E.065.630	630	552	773	95	396	6-8 weeks
P231E.065.710	710	622	871	100	433	6-8 weeks
P231E.065.800	800	701	981	100	467	6-8 weeks
P231E.065.900	900	788	1104	100	509	6-8 weeks
P231E.065.1000	1000	876	1227	100	547	6-8 weeks

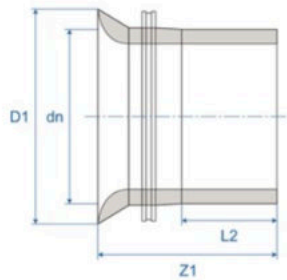



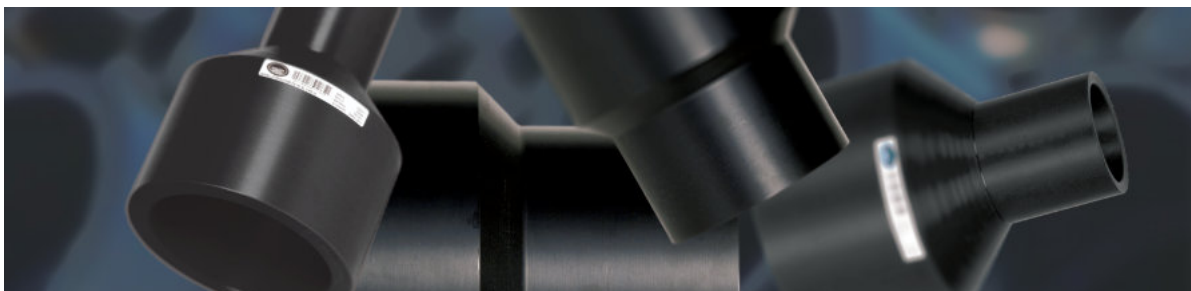

## Reducers

**Fabricated Eccentric reducers:** Eccentric reducers are designed to maintain the pipelines level invert. This maintains flow at the bottom of the pipe and prevents sediment from forming at the size change. Commonly used where velocities are low, Eccentric reducers are machined from hollow PE100+ bar in any size combination required.

Standard dimension tables for typical reducers are given below, these are limited to two size reduction, however, fabricated reducers provide the opportunity for large step changes, stepping down several pipe sizes in a single reducer. This can be beneficial where a large reduction needs to take place with limited space, for example, dn355 to dn110 where space prohibits the connection of four standard reducers in a line with couplers to make the diameter change.

Step reducers are machined from extruded hollow bar to accommodate step-change over a short distance. All variants of reducers are not listed in the tables but are manufactured to order on request. Available in black and single piece orders, contact us for special requirements.



*Product specifications and dimensions are subject to change without notice.*

*For the latest information refer to our website: [www.millpro.com.hk](http://www.millpro.com.hk) or contact our [sales team](#).*

## Black Moulded Reducers / RES / PN0.5 / SDR17

Product Code	dn1	dn2	le1	le2	Z	Availability in Hong Kong
P531E.12.160110	160	110	90	95	310	8-12 weeks
P531E.12.225160	225	160	100	150	404	8-12 weeks
P531E.12.280225	280	225	150	250	540	8-12 weeks

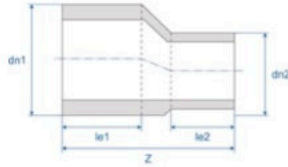

## Black Fabricated Reducers

Mill-Pro PE100+ black spigot eccentric reducers are either injection moulded or machined from extruded hollow bar with factory butt-welded spigots for electrofusion joining in larger sizes. Standard sizes are shown below, however, fabricated reducers can be any size and this allows for significant reductions to be made in any size up to dn2000. All reducers feature 1D and 2D bar code stickers for complete product traceability and are sealed in individual plastic bags for protection on site.

Listed below are standard reductions, however, we manufacture reductions in any combination of dn1 & dn2.

PN10 SDR17	PN16 SDR11	dn1	dn2	le1	le2	Z	Availability in Hong Kong
P5314.12.200160	P5316.12.200160	200	160	200	150	390	4-6 weeks
P5314.12.225200	P5316.12.225200	225	200	200	200	425	4-6 weeks
P5314.12.250200	P5316.12.250200	250	200	200	200	450	4-6 weeks
P5314.12.250225	P5316.12.250225	250	225	200	200	425	4-6 weeks
P5314.12.280225	P5316.12.280225	280	225	200	200	455	4-6 weeks
P5314.12.280250	P5316.12.280250	280	250	200	200	430	4-6 weeks
P5314.12.355280	P5316.12.355280	355	280	300	200	575	4-6 weeks
P5314.12.400355	P5316.12.400355	400	355	300	300	645	4-6 weeks
P5314.12.450355	P5316.12.450355	450	355	400	300	795	4-6 weeks
P5314.12.450400	P5316.12.450400	450	400	400	300	750	4-6 weeks
P5314.12.500400	P5316.12.500400	500	400	400	300	800	4-6 weeks
P5314.12.500450	P5316.12.500450	500	450	400	400	850	4-6 weeks
P5314.12.560450	P5316.12.560450	560	450	600	400	1110	4-6 weeks
P5314.12.560500	P5316.12.560500	560	500	600	400	1060	4-6 weeks
P5314.12.630500	P5316.12.630500	630	500	600	400	1130	4-6 weeks
P5314.12.630560	P5316.12.630560	630	560	600	600	1270	4-6 weeks

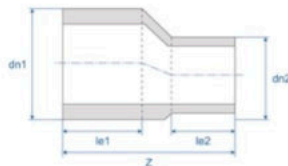



## Odour Abatement Device

OAD (Odour Abatement Devices), also known as **Odour Control Device** or **Odour Management Device**. These are Polyethylene inserts with Activated Charcoal filter cartridges. They drop inside standard Hong Kong 600mm Square or split manhole frame (DS 1077 A) to absorb foul gas (H<sub>2</sub>S) that is released from gravity drainage or Air valves during the operation of sewerage rising mains.

As the foul gas in the chamber builds up, it is forced past the valve and through the cartridge filter, before exiting to Atmosphere out the manhole cover. The replaceable cartridge is filled with a special activated carbon which absorbs the smell associated with H<sub>2</sub>S gas.

**The Mill-Pro OAD is designed with the following features to maximise cartridge life:**

- **Rain Guard** – to protect the Activated Carbon from being saturated by surface water leaking past the chamber lid.
- **High Pressure bypass valve** – vents large quantities of Air (filling the pipeline) to atmosphere so as to not damage the media.
- **Expansion Bag** – absorbs pressure changes inside the chamber to reduce media saturation
- **Media protection valve** – prevents the activated Charcoal from being continually depleted due to constant gas exposure.

Without the expansion bellows and the media protection valve the foul gases in the chamber saturate the media in the cartridge after a short period of time and render it ineffective. These features preserve the absorbent ability of the media providing an typical annual replacement cycle, rather than after just a few months.

Mill-Pro is the official Hong Kong agent for **MOE** (Manhole Odor Eliminator).

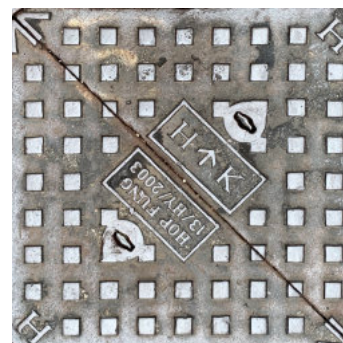

*Product specifications and dimensions are subject to change without notice.*

*For the latest information refer to our website: [www.millpro.com.hk](http://www.millpro.com.hk) or contact our [sales team](#).*

## MOE (Manhole Odour Eliminator)

The Manhole Odor Eliminator is an innovative solution to control the unpleasant smells that rise from sewer vents, grease traps, and manholes. Underground sewer systems let foul and potentially toxic gases pass through manholes into public areas. This can lead to nuisance complaints and even health and safety concerns. However, most activated carbon air filtration systems are expensive to maintain and can't effectively manage the changing airflow typical of sewer systems.

The MOE™ is a unique system that fits under the manhole cover. This includes an insert, carbon filter cartridge and bladder. The bladder buffers the fluctuations of sewer gas so that the odor absorbent carbon only has to treat the peak gas flow. This reduces the need to change out the carbon filter saving cost and time consuming services.



## Standard Filters

Standard filter cartridges for the Manhole Odor Eliminator contain activated carbon based filter media. Other media can be installed depending on what odor causing gasses are present in the manhole.

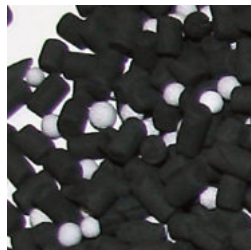

## Color Indicating Media

Hydrogen Sulfide (H<sub>2</sub>S) detecting media is available for the Manhole Odor Eliminator. This media changes color depending on the concentration of H<sub>2</sub>S it has been exposed with. Examining the media when changing the filter cartridge helps set the maintenance schedule to maximize filter life.





## Bladder replacement

A bladder buffers the fluctuating pressures in the manhole. Here a cutaway demo MOE™ is being test fit. The yellow bladder is visible below the carbon filter.



## Support Funnel

A Manhole Odor Eliminator is being installed with a stainless steel support funnel. Plastic support funnels are also used depending on the size and style of the manhole.





## Rehabilitation Products

Polyethylene is one of the most commonly used materials globally in the rehabilitation of existing pipelines (Water, Gas and Wastewater). The methods of rehabilitation vary considerably depending on the situation. Typically in water pressure mains, the objective is to maximise the internal bore of the rehabilitated pipe in order to maintain existing flow rates at a given pressure, so close and tight fit (pipe in pipe) liner solutions are more typical.

The other main factor is the 'condition assessment' of the existing main to determine its ability to provide a suitable host pipe for the PE liner and if additionally, it can provide structural support to the PE liner to create a composite pipe (existing host and PE combine to provide a single structural member). In Hong Kong, there are very few if any 'semi-structural liners' installed. It's more typical that the host pipe is only used to provide a path for the new PE liner, the PE liner pipe is fully structural in its own right.

Using Polyethylene to rehabilitate existing Ductile Iron and Steel pipelines that have reached the end of their operational life, is commonplace around the world. Approximately 50% of the Hong Kong Water Supplies Department's 5700km drinking and flushing water supply network was either rehabilitated or replaced between Years 2000 to 2015, the majority was repaired or replaced using Polyethylene pipes.

Rehabilitation using PE typically involves the insertion of a custom size (non-standard pipe OD) PE pipe inside an existing host pipe, from point to point without excavation in-between. There are many techniques and methods available to perform this kind of rehabilitation in sizes from DN50 to DN2000 and larger

For more information on rehabilitation methods and polyethylene products, request our presentation on ***Rehabilitation***.

*Product specifications and dimensions are subject to change without notice.*

*For the latest information refer to our website: [www.millpro.com.hk](http://www.millpro.com.hk) or contact our [sales team](#).*

## Kwik-ZIP Pipeline Spacers

Pipeline spacers are a non-metallic spacer used in pipeline rehabilitation and new construction. The main type used with PE pipes is a "**Bow Spring Type**", such as the HD series pipe spacer. If the liner pipe is heavier (such as steel, DI pipes or very large PE pipes) then a stronger "**Casing Spacer**" such as the HDX or HDXT may be required.

Pipe Spacers are used in applications where a smaller diameter liner pipe is being hosted in a new or existing host pipe. This may be due to rehabilitation of an old host pipe or installing a PE liner pipe inside a jacked steel pipe that provides a sacrificial host pipe for construction purposes. The purpose of the spacer pipe is to

- Centre the liner pipe inside the host pipe to ensure even grouting of the annulus and maintain gradient if necessary.
- Withstand grout pressure up force on the PE pipe to maintain an annulus around the PE pipe for grout to flow into.
- Reduce pulling or jacking friction during the installation process
- Prevent damage and wear to the PE pipes outer surface as it is pulled into the host pipe

Spacers come in various formats and materials, some have wheels, runners or skids. They can contain multiple pipes in a single host pipe, however, most common is a low-cost sacrificial spacer manufactured from engineering plastic. These clamp onto the pipe surface with a given spacing between each spacer both along and around the pipe. The spacings are determined by the mass of the liner pipe and the expected wear rate based on the length of the pull.

### Key requirements for pipeline rehabilitation spacer are:

- Ability to grip onto the surface of the pipe and not slip or 'stack up' during the pull – features such as rubber pads to grip to the pipe surface and mechanical banding through the spacer onto the pipe may be required where frictions loads are expected to be high where the annulus gap is small.
- Non-rigid design so the spacer can deflect to allow passage of the pipe through tight areas but has sufficient rebound strength to recover to its original spacer height under static load in order to maintain an even grouting annulus
- Provide load sharing between runners – as the liners mass is focused onto a small radial area during the pull (around bends), the deflection of the spacer must allow the excessive load on one spacer skid to deflect so it is shared between the adjacent skids when required and then recover its normal height.
- Offers various wear resistance options for the runner surfaces such as POM (acetal or polyacetal) and UHMWPE (Ultra-high-molecular-weight polyethylene) to allow tailoring of wear on the spacers given the host pipe condition and respective pull lengths.
- Allow rapid installation on-site around the circumference of the liner pipe in the pit as it is being pulled in to the host pipe, to avoid construction delays.



## HD Series – Bow Spring centralisers

The HD series is available in 4 standard bow heights:

- **HD 30** - 30mm high bow spring
- **HD 50** - 50mm high bow spring
- **HD 75** - 75mm high bow spring
- **HD 100** - 100mm high bow spring

Special custom heights may be manufactured to order. The HD series snap together with an adjustable strap and will wrap around any size pipe from 110mm OD to 2000mm OD. They feature rubber pads on each bow to grip on the pipe surface and tension screws.

Installation is a one man job either in the trench before each Jack or winch or above ground on each pipe sections for live installations. Additional stainless steel banding may be applied around the fitted clamps to resist excessive installation forces in direct drilled (HDD) or host pipes with a rough interior.



## Agro Sureline

Sure-Grip is a well-established concrete protective liner with a stud height of 13 mm and is suited for new constructions, tank rehabilitation, and precast elements such as concrete pipes and manholes. Sure-Grip comes available in a host of material types including polypropylene, polyethylene, PVDF, and ECTFE. Available colors include grey, black, and yellow. For advanced requirements, AGRU is also able to manufacture Sure-Grip type 571 with a stud height of 19 mm. Special dimensions and product specifications can be made available on request.







[millpro.com.hk](http://millpro.com.hk)



### HONG KONG

[info@millpro.com.hk](mailto:info@millpro.com.hk)

phone +852 2543 6200

office Room 2102, 21/F Tai Yip Building,  
141 Thomson Road, Wan Chai, **HK SAR**

### NEW ZEALAND

[info@millpro.co.nz](mailto:info@millpro.co.nz)

phone +64 6 836 7919

post PO Box 7014 Taradale, **Napier 4141**

